



Portable Theater Quick Guide

DP1B DP1W



- This user manual contains instructions on how to use the product properly.
- Please read this manual carefully. Be sure to follow the instructions and notices.
- GUI and package contents are subject to change without prior notice to improve the product quality.
- To view HD quality resolution, you must connect the HDMI cable.
- Firmware can be updated frequently to improve the product quality.
- To download the latest firmware, please visit www.lg.com or www.lgservice.com

* Manufactured under license from Dolby Laboratories.

* "Dolby" and the double-D symbol are trademarks of Dolby Laboratories

Copyright / Open Source Software Notice

Copyright

Under the U.S. Copyright laws and Copyright laws of other countries, unauthorized recording, use, display, distribution, or revision of television programs, videotapes, BD-ROM discs, DVDs, CDs and other materials may subject you to civil and/or criminal liability.

Open Source Software Notice

The following GPL executables and LGPL libraries used in this product are subject to the GPL2.0/LGPL2.1 License Agreements

GPL EXECUTABLES :

Linux kernel 2.6, bash, busybox, cramfs, dhcpcd, e2fsprogs, fdisk, mkdosfs, mtd-utils, net-tools, procps, samba-3.0.25b, sysutils, tcpdump, tftpd, tinylogin, unzip, utelnetd

LGPL LIBRARIES :

uClibc, DirectFB, blowfish, cairo, ff mpeg, iconv, libusb, mpg123

gSOAP Public License 1.3 LIB :

Gsoap

LG Electronics offers to provide source code to you on CD-ROM for a charge covering the cost of performing such distribution, such as the cost of media, shipping and handling upon e-mail request to LG Electronics at : opensource@lge.com

This offer is valid for a period of three(3) years from the date of the distribution of this product by LG Electronics. You can obtain a copy of GPL, LGPL license from <http://www.gnu.org/licenses/old-licenses/gpl-2.0.html>, <http://www.gnu.org/licenses/old-licenses/lgpl-2.1.html>

This software is based in part on the work of the Independent JPEG Group copyright© 1991-1998, Thomas G. Lane.

This product includes

- Boost C++ : copyright© Beman Dawes 1999-2003
- c-ares : copyright© 1998 by the Massachusetts Institute of Technology
- Curl : copyright© 1996-2008, Daniel Stenberg
- Expat : copyright© 2006 expat maintainers
- Freetype : copyright© 2003 The FreeType Project (www.freetype.org)
- Jpeg : This software is based in part on the work of the Independent JPEG Group copyright© 1991-1998, Thomas G. Lane.
- Mng : copyright© 2000-2007 Gerard Juyn, Glenn Randers-Pehrson
- Ntp : copyright© David L. Mills 1992-2006

Open Source Software Notice

OpenSSL :

- cryptographic software written by Eric Young (eay@cryptsoft.com).
- software written by Tim Hudson (tjh@cryptsoft.com)
- software developed by the OpenSSL Project for use in the OpenSSL Toolkit.
(<http://www.openssl.org>)
- Png : copyright© 2004 Glenn Randers-Pehrson
- Portmap : copyright© 1990 The Regents of the University of California
- Ptmalloc : copyright© 2001-2006 Wolfram Gloger
- UnitTest++ : copyright© 2006 Noel Llopis and Charles Nicholson
- UPnP SDK : copyright© 2000-2003 Intel Corporation
- Strace :
copyright© 1991, 1992 Paul Kranenburg
copyright© 1993 Branko Lankester
copyright© 1993 Ulrich Regelow
copyright© 1995, 1996 Michael Elizabeth Chastain
copyright© 1993, 1994, 1995, 1996 Tick Sladkey
copyright© 1999, 2000 Wichert Akkerman
- Xml2 : copyright© 1998-2003 Daniel Veillard
- XML-RPC For C/C++ :
copyright© 2001 by First Peer, Inc. All rights reserved.
copyright© 2001 by Eric Kidd. All rights reserved.
- Zlib : copyright© 1995-2002 Jean-loup Gailly and Mark Adler. All rights reserved.

Permission is hereby granted, free of charge, to any person obtaining a copy of this software and associated documentation files (the Software), to deal in the Software without restriction, including without limitation the rights to use, copy, modify, merge, publish, distribute, sublicense, and/or sell copies of the Software, and to permit persons to whom the Software is furnished to do so, subject to the following conditions:

The software is provided "AS IS", without warranty of any kind, express or implied, including but not limited to the warranties of merchantability, fitness for a particular purpose and no infringement. In no event shall the authors or copyright holders be liable for any claim, damages or other liability, whether in an action of contract, tort or otherwise, arising from, out of or in connection with the software or the use or other dealings in the software.

Table of contents

Copyright / Open Source Software Notice	2	Playing a Video File	
Open Source Software Notice	3	General Playback Using colored buttons (R, G, Y, B) ...	48
Cautions & Warnings	5~6	General Playback	49
General Information		Slow Fast Forward / Rewind	
Compatibility Notes	7	Fast Forward / Rewind Skip (5 min)	50
Package Contents	8	Previous / Next file playback Repeat Information	51
Name of Parts	9	Enlarge the Playback Video Time Search	52
Remote control	10~13	On-Screen Display	53
Touch Button	13	Selecting Audio dubbing Selecting Subtitle file	54
USB Device Connection / Stand Installation	14	Video files	55
Connecting to your TV	15~16	Listening to Music File	
Connecting to an Amplifier	17~18	General Playback	56
Connecting to your Home Network		General Playback Fast Forward / Rewind	
Wired Network Connection	19	Repeat Playback	57
Wireless Network Connection	20	Previous / Next file playback Information	58
Notes on Network Connection	21	Viewing a Photo File	
Home Menu	22	General Playback	59
Video / Audio Setting	23	Repeat Playback Enlarge the Playback Image	60
Digital Audio Output		On-Screen Display	61
Audio Output Specifications	24	Playing YouTube Videos	
TV Aspect Ratio	25	About YouTube Menu	62
Resolution	26	Playing YouTube Videos	63
Resolution Setting	27	Sign in / Sign out	64
Brightness Contrast	28	Searching Videos	65
HDMI Color Setting	29	Viewing Picasa Web Albums	
Network Setting		About Picasa Web Albums Menu	66
Connection Setting	30~32	Viewing Picasa Web Albums	67
Connection Status	33	Sign in / Sign out	68
Device Name	34	Searching Photos	69
Sharing on Network Auto Login		Adding NetCast friends	70
Clear Login Information	35	Using the AccuWeather	71
Disclaimer Notice	35	Playing content via your home network	
Others Setting		Accessing a DLNA media server	72~73
Menu Language Setting	36	Entering a network user ID and the password	
DivX VOD	37	Sharing files and folders	74
Power Mode	38	File Compatibility	75
Screen Saver	39	Trouble Shooting	76~79
Information Initialize	40	IMPORTANT INFORMATION RELATING	
Software (Firmware Upgrade)	41	TO NETWORK SERVICES	80
USB Device Connection		Trademarks and Licenses	81
USB Device Connection	42	Specification	82
Caution During Using USB Device	43	LG Service Site	83~84
File Setting			
File Information File Search	44		
File Copy	45		
File Rename	46		
File Delete	47		

Cautions & Warnings

- This user manual contains instructions on how to use the product properly.
- Please read this manual carefully.
- Be sure to follow the instructions and notices.

● Notes are divided into "Warning", "Caution" and "Tip" each denotes the following:



Warning

Failure to follow the instructions below may result in injuries or product damage.



Caution

Failure to follow the instructions below may result in serious injuries or product damage.



Tip

It provides a recommendation to prevent product failure or malfunction in advance when using the product.



Warning

- LG EXCLUDES LIABILITY FOR ALL CONSEQUENTIAL AND OTHER LOSS, INCLUDING LOSS OF DATA.
- Defects may occur under following circumstance.
 - : Keep away from humidity, dust, and soot (may cause fire or electrocution).
 - : Keep away from areas with temperature of above 35 °C (95 °F).
 - : Keep away from magnetic fields, water, heat.
 - : Do not use during thunder and lightning.
 - : Do not drop the product or place heavy objects on it.
- Make sure no dust or other foreign matter gets inside the port.
It may cause data damage.
- Do not pull out the USB cable while the product operating.
(The product may malfunction.)
- If smoke, unpleasant odor or noise is produced, unplug the power and peripherals immediately and remove all cables.

Cautions & Warnings



Cautions

- DO NOT PLACE THIS PRODUCT WHERE IT CAN BE REACHED BY CHILDREN. THE PRODUCT CAN GET HOT WHILE WORKING. IT MAY RESULT IN BURNS.
- Do not touch the heat vent when the product is operating. It may become hot and may result in burns.
- Intended for personal use. Do not use for commercial purposes.
- Do not use the product for a long time without cooling it down.
- Do not drop the product or place heavy objects on it.
- This product is intended for use with TV's and monitors. Do not use this product for anything other than its intended purpose.
- Do not touch the power plug with wet hands. Additionally, if the cord pin is wet or covered with dust, dry the power plug completely or wipe dust off. You may be electrocuted due to moisture.
- Do not attempt to modify this product in any way without authorization from LG Electronics. Unauthorized modification could void the user's authority to operate this product
- Please read this manual carefully before using the product. If you abuse the product, it can be damaged.

❖ Compatibility Notes

Compatibility Notes

- To display full HD contents, the TV with HDMI port is required.
- This player supports Dolby digital and DTS 5.1 Channels if an amplifier / receiver is connected using a HDMI cable or a Optical Digital audio cable.
- OGG and FLAC (Audio codec) only support audio files. (Video files are not supported.)
- This product is not support external Blue ray Drive and DVD Drive.

Certain System Requirement

Requirement for HD content display

- To display full HD contents, the TV with HDMI port is required.
 - To connect TV or monitor with DVI port, please use the HDMI-DVI conversion cable, and please connect Optical Digital audio cable or composite cable for audio.
 - The USB Storage device including HD contents is required.
- For up-conversion of standard definition DVD, a HDMI or HDCP capable DVI input on your display device is required for copy protected content.

Requirement for Dolby Digital Audio playback.

- Amplifier with Dolby Digital or DTS decoder (A/V receiver)
- 5.1 Channel speaker
(Front surround speaker, Rear surround speaker, Center speaker, Sub woofer)

AVCHD

AVCHD (Advanced Video Codec High Definition)

- This player can playback AVCHD format. These format is normally recorded and used in camcorders.
- The AVCHD format is a high definition digital video camera format.
- The MPEG-4 AVC/H.264 format is capable of compressing images at higher efficiency than that of the conventional image compressing format.
- Some AVCHD format use the "x.v.Color" format.
- This player can playback AVCHD format using "x.v.Color" format.
- Some AVCHD format may not play depending on the recording condition.
- "x.v.Color" is trademarks of Sony Corporation.
- "AVCHD" and the "AVCHD" logo are trademarks of Panasonic Corporation and Sony Corporation.

Package Contents

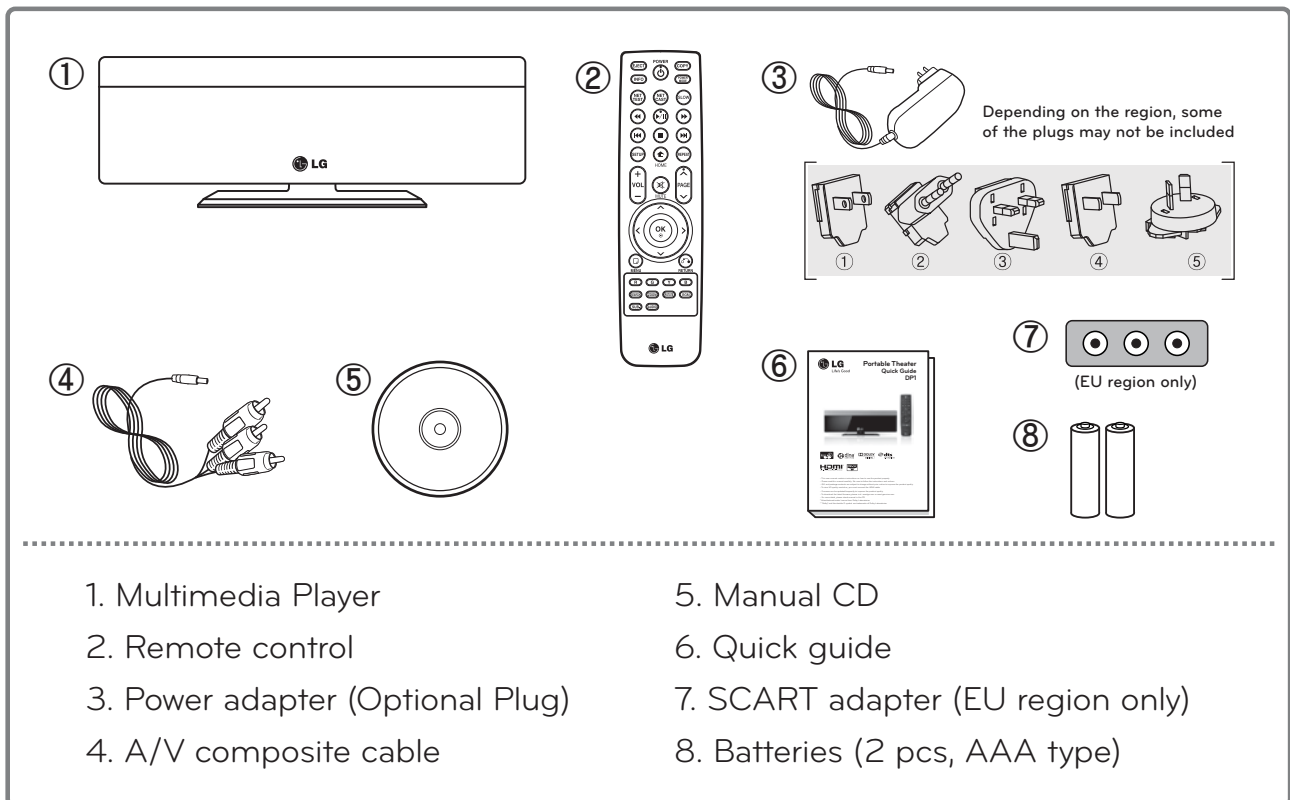

- ※ Check to make sure that you have all the components shown above.
If there are any problems with the package contents,
please consult the store or retailer.
- ※ The accessories included may differ from the images.
- ※ Components are subject to change without prior notice to improve
the product quality.
- ※ Depending on the region, some of the plugs may not be included.

<< Note for cable connection >>

- Connect the audio/video connection securely.
(Please see the User's manual of TV or monitor for your reference.)
- After audio/video connection, plug in the product to protect it from over heat
and electric shock.
- Connect the A/V composite cable properly to corresponding jack.

Name of Parts

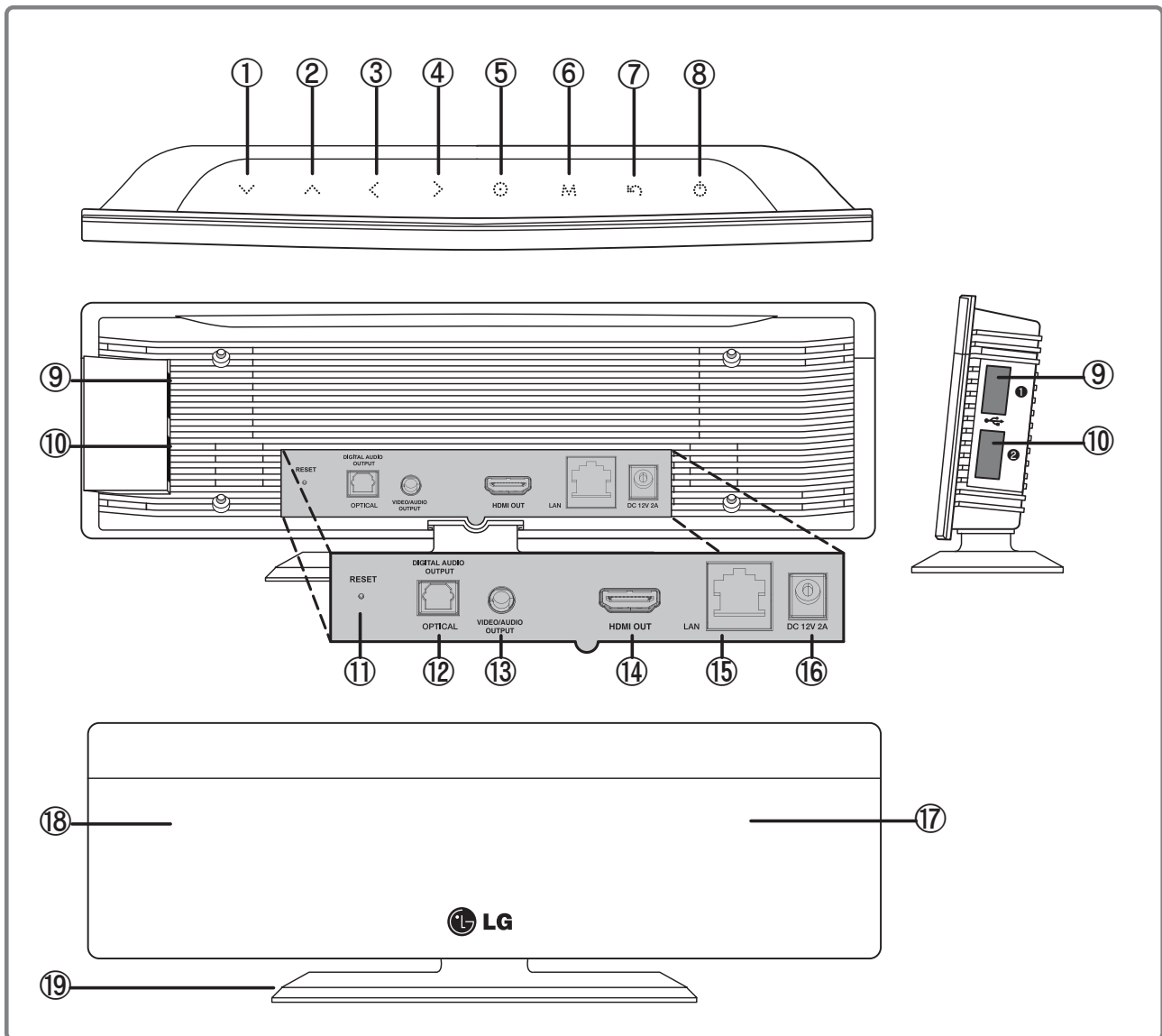





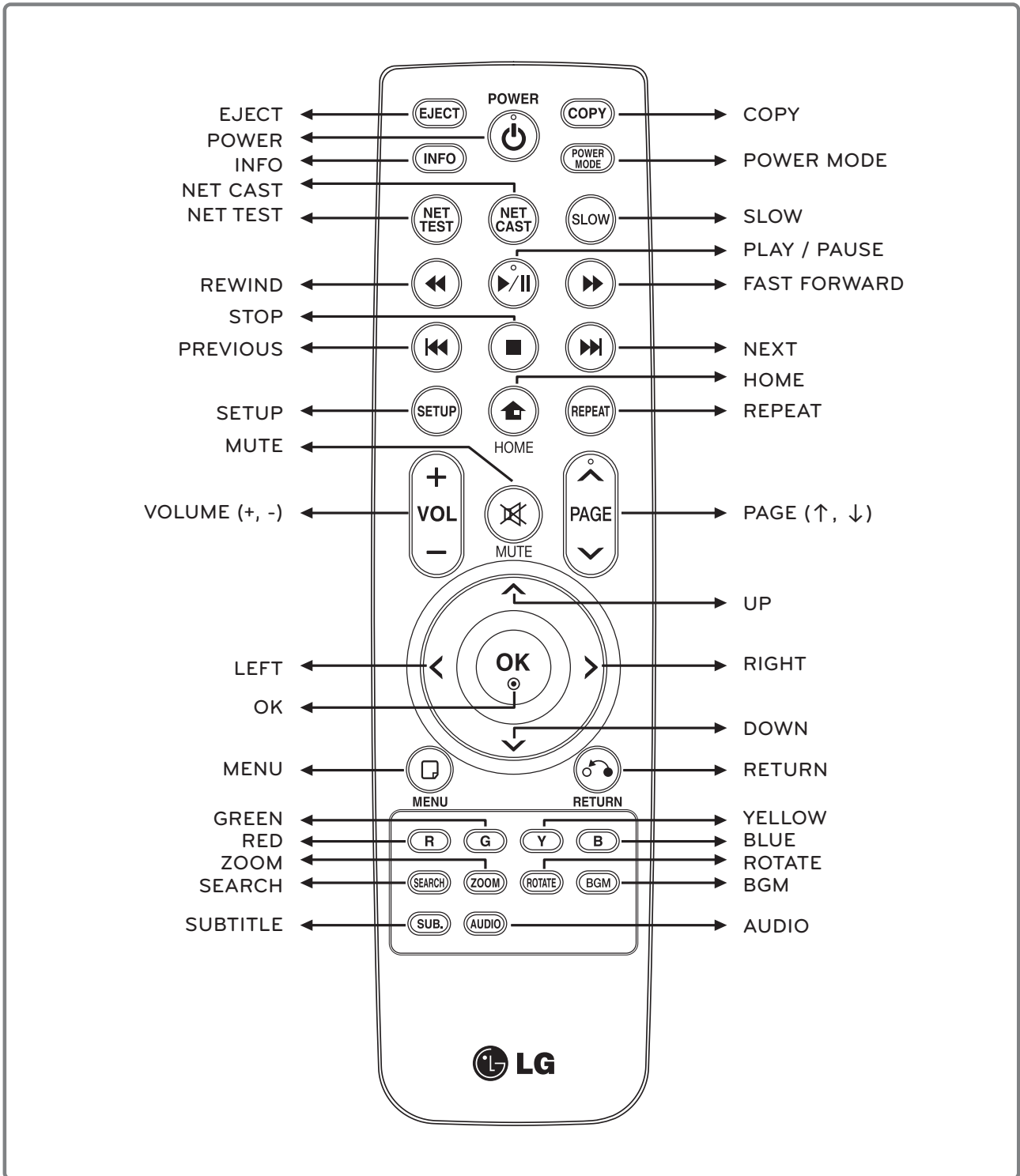















- | | |
|-----------------------------|--|
| 1. Direction (Down) Button | 11. Reset Button |
| 2. Direction (Up) Button | 12. Digital audio out port (Optical) |
| 3. Direction (Left) Button | 13. A/V composite port (Phone jack type) |
| 4. Direction (Right) Button | 14. HDMI port |
| 5. OK Button | 15. LAN port |
| 6. Menu Button | 16. Power supply connector (12 V, 2 A) |
| 7. Return Button | 17. Status LED |
| 8. Power Button | 18. Remote Control Sensor |
| 9. USB Host port 1 | 19. Stand |
| 10. USB Host port 2 | |

Remote control



















If you press and hold the button, it may jump to the next step due to the remote control sensitivity.

Remote control

	POWER	Turn on / off power
	EJECT	USB safely remove
	COPY	File copy
	INFO	Display the file information
	POWER MODE	Change power mode (Power Off – Network – Check Mode)
	NET TEST	Network connection test
	NET CAST	Display YouTube, Picasa, AccuWeather
	SLOW	Play movie slowly in full screen mode
	PLAY / PAUSE	Play / pause the file
	REWIND	Rewind the movie or music playback
	FAST FORWARD	Forward the movie or music playback
	STOP	Stop playing
	PREVIOUS	Play the previous file, movie chapter
	NEXT	Play the next file, movie chapter
	SETUP	Go to the setup menu
	HOME	Go to the main menu
	REPEAT	Change the repeat function of movie, music, photo
	VOLUME (+, -)	Increase / decrease the volume (To maximize the volume, increase the TV volume)
	MUTE	Mute / resume audio output
	PAGE (↑, ↓)	Go to the next / previous page of the list

Remote control

	OK	Confirm / play selected file Display the status bar during playing movie, photo
	DOWN	Move down
	UP	Move up
	LEFT	Move left, Move to 5 minutes before in movie full screen mode
	RIGHT	Move right, Move to 5 minutes after in movie full screen mode
	MENU	Go to option menu
	RETURN	Stop / return playing file Go to upper folder / menu
	RED	Control function button
	GREEN	Control function button
	YELLOW	Control function button
	BLUE	Control function button
	SEARCH	File search, Playback navigation available in movie full screen mode
	ZOOM	Zoom in / out during movie, photo playing
	ROTATE	Rotate the photo to 90 degrees (Clockwise) in full screen mode
	BGM	Background music customizable in photo full screen screen
	SUBTITLE	Subtitle setting
	AUDIO	Change the available audio track of movie

Remote control

❖ Battery Installation

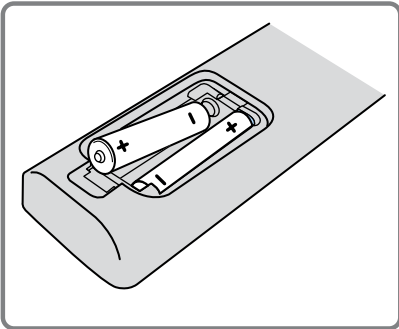

Remove the battery cover on the rear of the Remote control, and insert two R03 (size AAA) batteries with + and – matched correctly.

· Do not mix old or used batteries with new ones.

❖ Precaution in Installing the Product

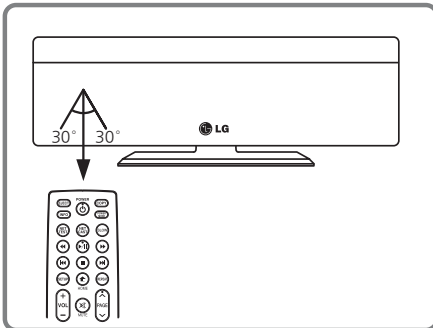

Point the remote control directly at the remote control sensor within 7 m.

Touch Button

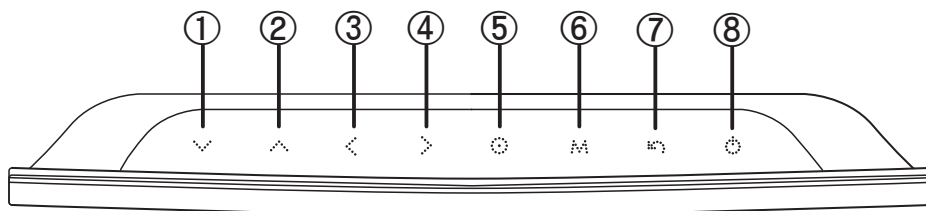

1	▼	DOWN	Move down
2	▲	UP	Move up
3	◀	LEFT	Move left, Move to 5 minutes before in movie full screen mode
4	▶	RIGHT	Move right, Move to 5 minutes after in movie full screen mode
5	⊙	OK	Confirm / play selected file Display the status bar during playing movie, photo
6	☰	MENU	Go to option menu
7	⏮	RETURN	Stop / return playing file Go to upper folder / menu
8	⏻	POWER	Turn on / off power

USB Device Connection / Stand Installation

❖ USB Device Connection

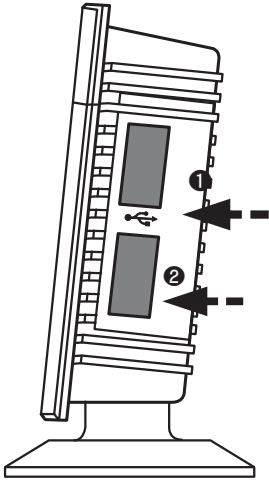

- ※ If you lack USB port space or a USB port is blocked due to multiple input devices, please utilize USB extension cables.
(USB extension cable is not included.)
- ※ This player can play movie, music and photo files contained in the USB drive, external HDD and flash memory card reader. When you connect a USB Storage device to the player, USB icon will be activated on file list mode.

<< Precaution in USB connection >>

- When you connect the 3.5 External HDD, use the power adapter as well.
(HDD would not be recognized due to insufficient power.)

❖ Stand Installation

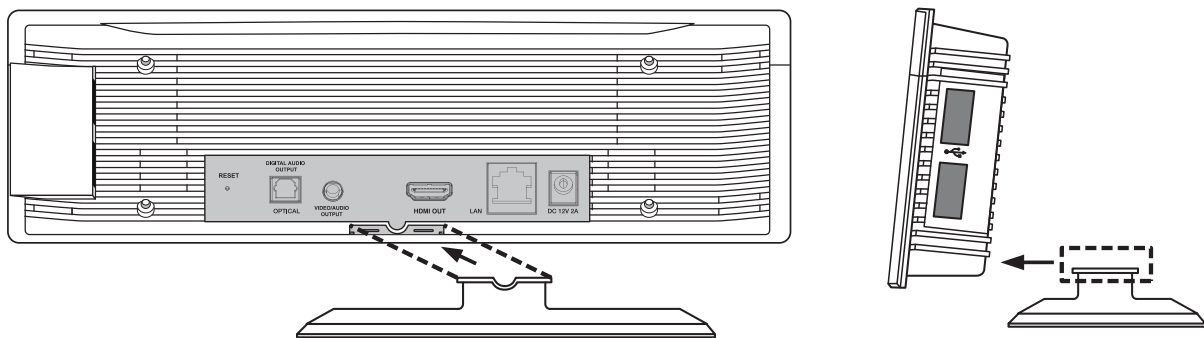

This high performance portable multimedia device supports Full HD capabilities. (It works properly without the stand as well.)

1. To secure the device into the stand, firmly support the back of the device from below while positioning the insertion tab into corresponding opening. Slide device forward to lock the device in place.
2. To disengage the stand, press lightly on it while sliding back and out of locking device.

Connecting to your TV

❖ HDMI Connection

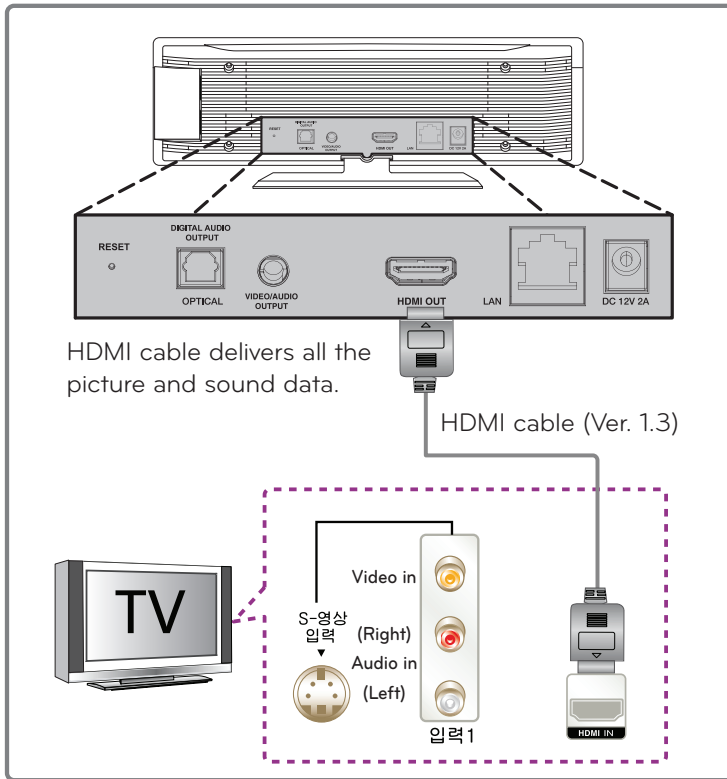

※ Additional Information for HDMI ※

- When you connect a HDMI or DVI compatible device make sure of the following:
 - Try switching off the HDMI/DVI device and this player. Next, switch on the HDMI / DVI device and leave it for around 30 seconds, then switch on this player.
 - The connected device's video input is set correctly for this unit.
 - The connected device is compatible with 720x480p, 1280x720p, 1920x1080i or 1920x1080p video input.
- Not all HDCP-compatible HDMI or DVI devices will work with this player.
 - The picture will not be displayed properly with non-HDCP device.
 - This player does not playback and TV screen is changed to black screen.
 - To view HD quality resolution you must connect the HDMI cable.

1. If you have a HDMI TV or monitor, you can connect it to this player using a HDMI cable (Type A, Version 1.3). Connect the HDMI jack on the player to the HDMI jack on a HDMI compatible TV or monitor.
2. When you use HDMI connection, you can change the resolution for the HDMI output (Auto, 480p, 720p, 1080i, 1080p)
(Refer to "resolution setting" chapter.)
3. Select the type of video output from the HDMI OUT jack using [HDMI Color Setting] option on [Setup] menu.

· It takes about few seconds (Maximum 30 seconds) to display Main menu after showing LG Logo.



※ What is SIMPLINK?

Some functions of this unit are controlled by the TV's remote control when this unit and LG TV's with SIMPLINK are connected through HDMI connection.

Controllable functions by LG TV's remote control; Play, Pause, Scan, Skip, Stop, Power Off, etc.
Refer to the TV owner's manual for the details of SIMPLINK function.
LG TV's with SIMPLINK function has the logo as shown above.

NOTE) Depending on the type or playing status, some SIMPLINK operation may differ from your purpose or not work.

Connecting to your TV

❖ Audio (Left / Right) / Video Connection

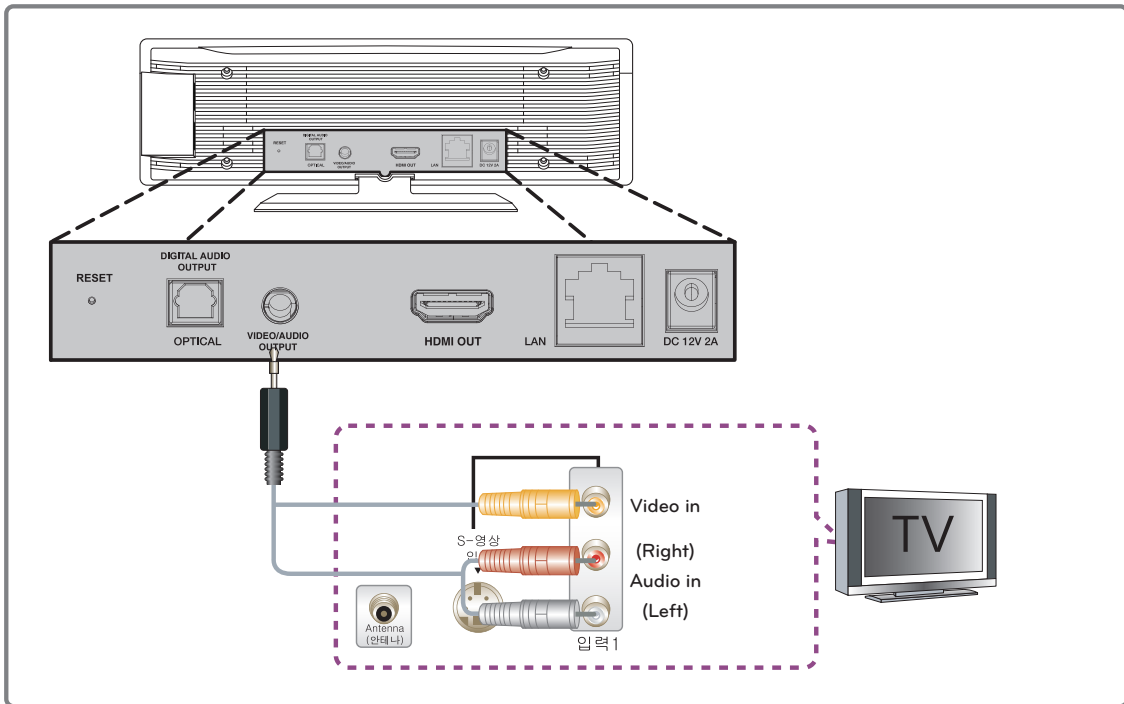

Connect the A/V Composite port on the player to the video / Audio jack on the TV using A/V Composite cable (Phone jack type).

- Depending on TV, it can be connected to [AV1], [AV2], [AV3] or [AV4]
- It takes about few seconds (Maximum 30 seconds) to display Main menu after showing LG Logo.

※ Power adapter connection

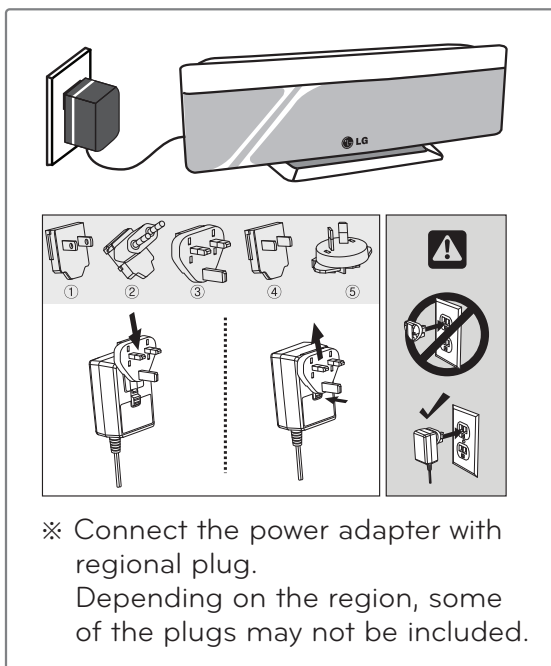

※ LED operating status

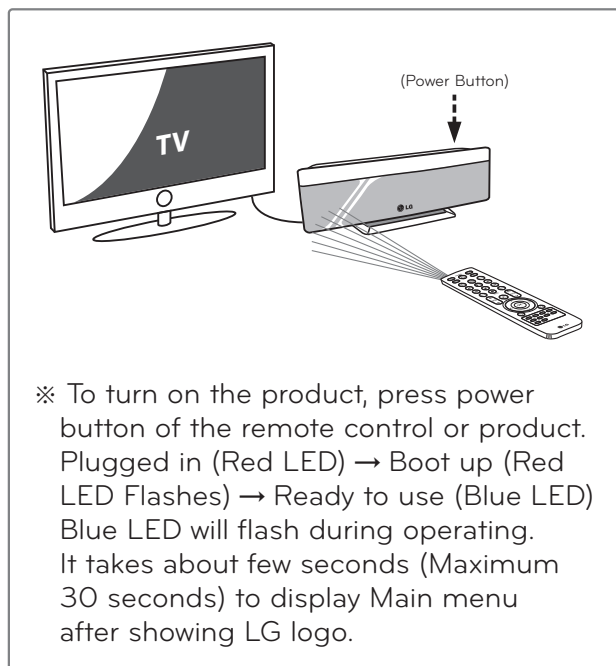

Connecting to an Amplifier

❖ Dolby Digital Amplifier | DTS Amplifier (High Quality Digital Audio)

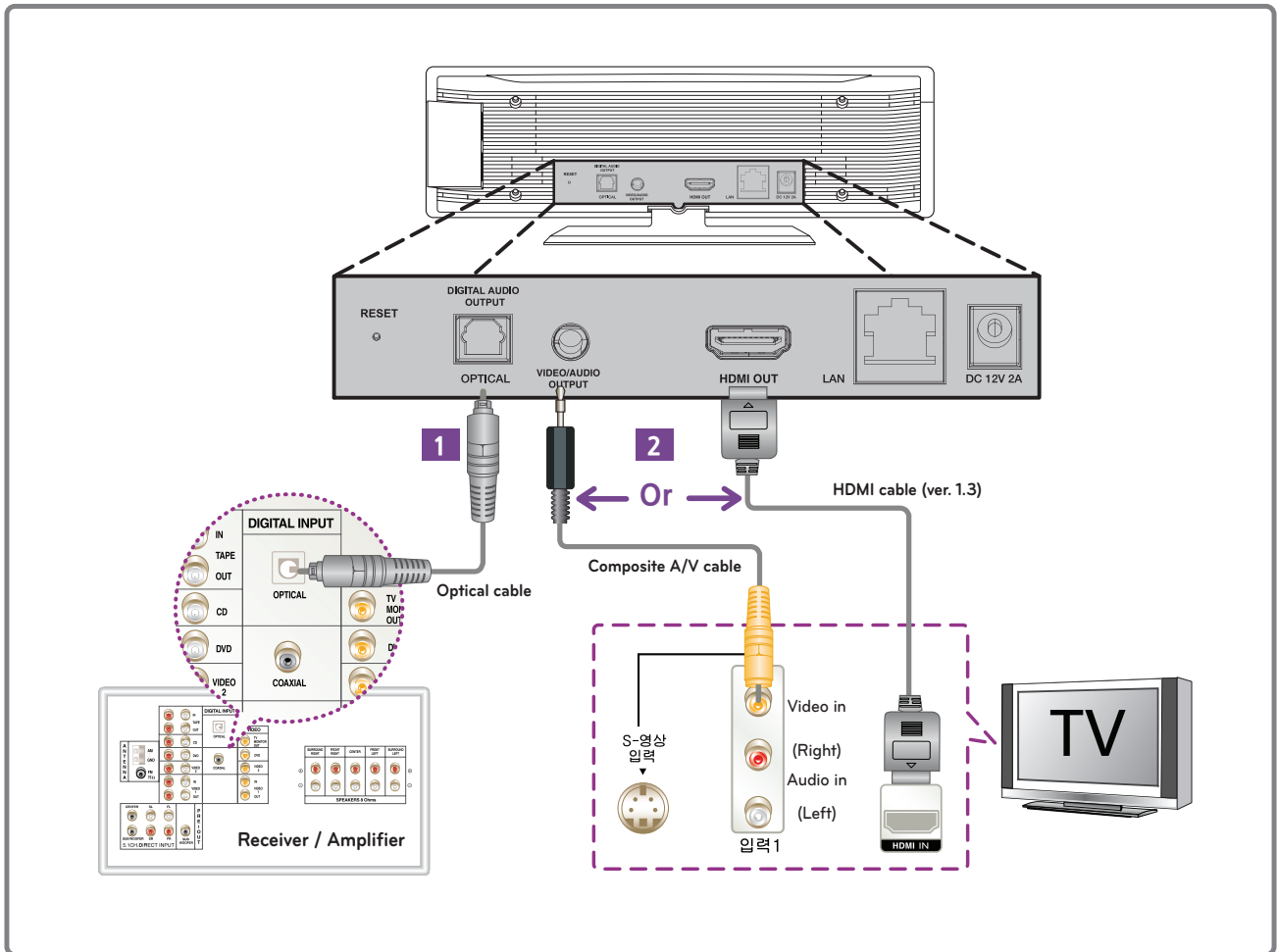

1. Connect the player's Digital audio out port (Optical) to the corresponding in optical jack on your amplifier. Use an optional digital audio cable. You will need to activate the player' digital output.
 - It supports surround sound.
2. Connect the player's [A/V composite port (phone jack type)] to TV's [Video in] port using a A/V composite cable, or Connect the player's [HDMI port] to TV's [HDMI in] port using a HDMI cable.

- Select the output sound format when a device equipped with a HDMI or Digital Audio input jack is connected to the HDMI OUT or DIGITAL AUDIO OUT jack on this player.
- Depending on the Amplifier or receiver, the port will be differ from image. Please see the User's manual of Amplifier.
- Output levels should be properly adjusted before use to prevent damage to the output device.

Connecting to an Amplifier

❖ Connecting to an Amplifier via HDMI Output

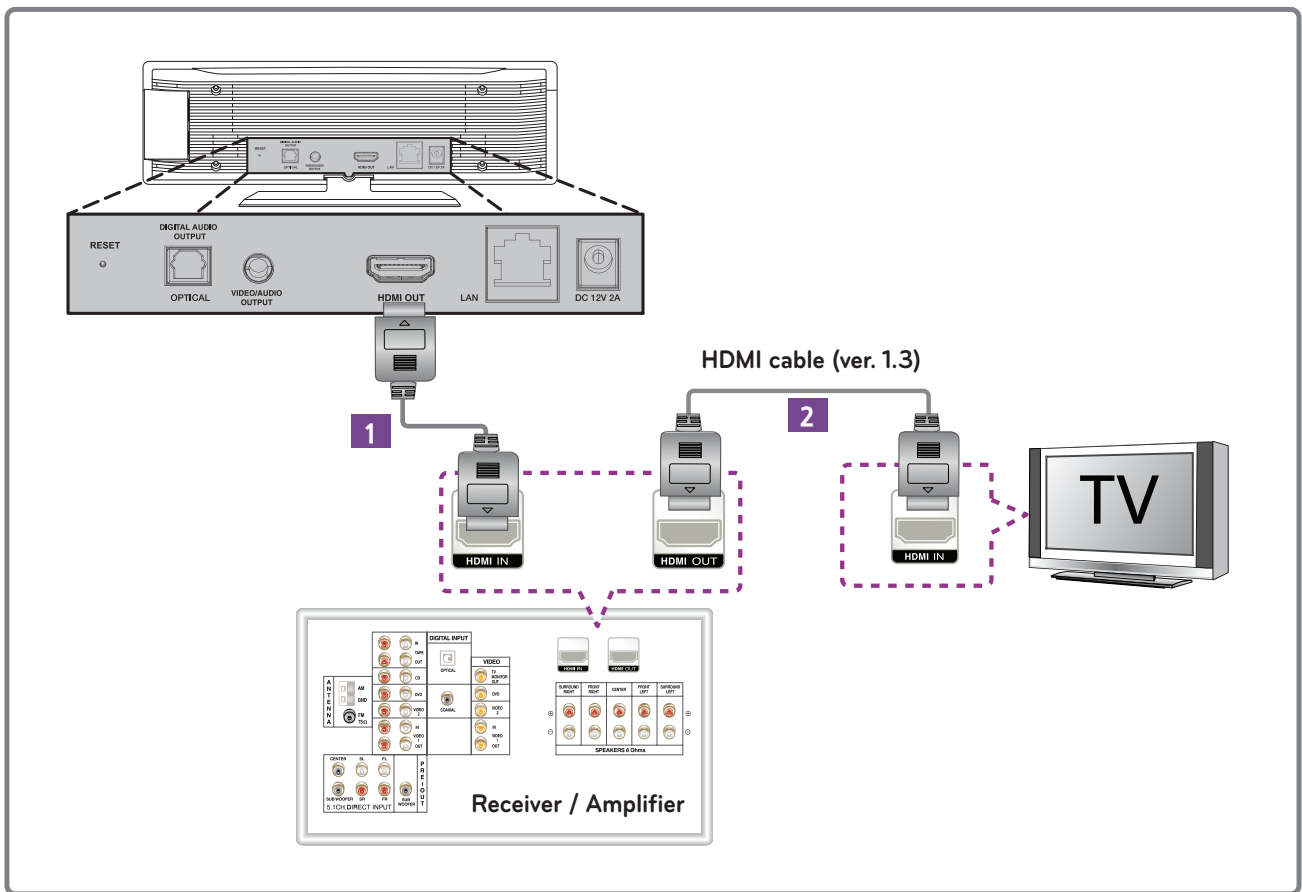

1. Connect the player's HDMI out jack to the corresponding in jack on your amplifier using a HDMI cable (ver. 1.3).
2. Connect the amplifier's HDMI output jack to HDMI input jack on your TV using a HDMI cable if your amplifier has HDMI jack. (to connect TV and amplifier using HDMI cable, please see the User's manual of amplifier for you reference.)

- Select the output sound format when a device equipped with a HDMI or Digital Audio input jack is connected to the HDMI OUT or DIGITAL.
- Depending on the amplifier, location of jack will be different. Please see the User's manual of amplifier for a reference.

Connecting to your Home Network

❖ Wired Network Connection

This player can be connected to a local area network (LAN) via the LAN port on the rear panel or the wireless device. By connecting the player to a broadband home network, you have access to service such as YouTube, Picasa and AccuWeather.

Connect the player's LAN Port(RJ-45) to the corresponding port on your Modem or Router using a commercially available LAN or Ethernet cable.

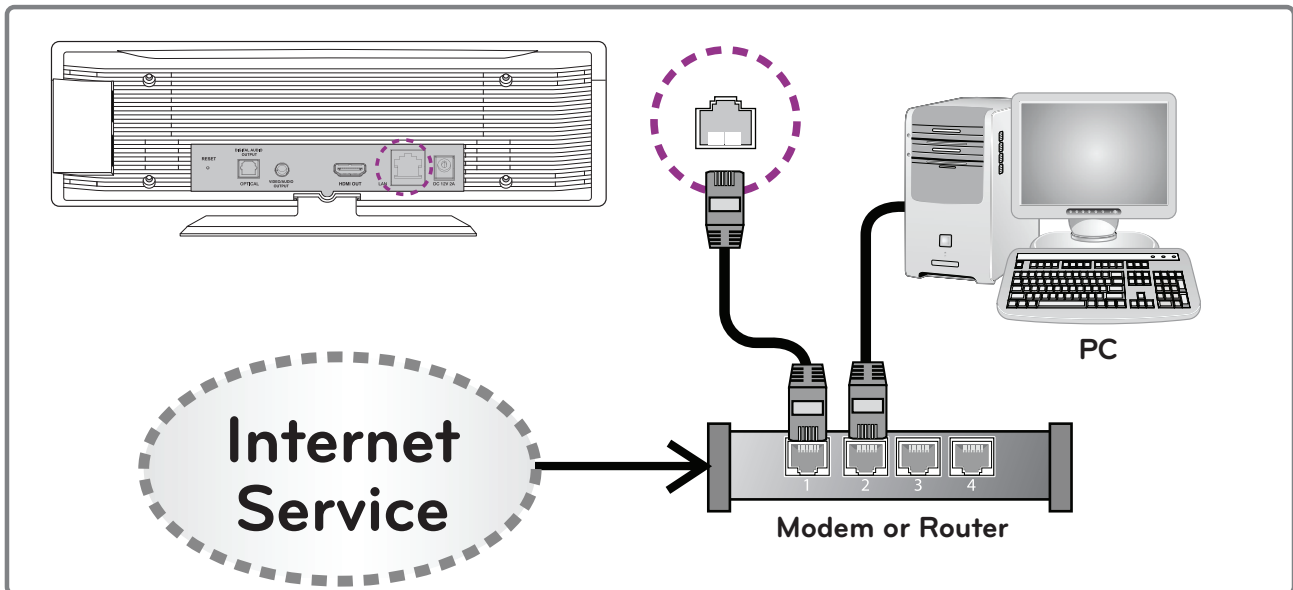

Using a wired network provides the best performance, because the attached devices connect directly to the network and are not subject to radio frequency interference.

Please refer to the documentation for your network device for further instructions.

Connect the player's LAN port to the corresponding port on your Modem or Router using a commercially available LAN or Ethernet cable (CAT5 or better with RJ45 connector).

In the example configuration for wired connection above, this player would be able to access content from either of the PCs.

If there is a DHCP server on the local area network (LAN) via wired connection, this player will automatically be allocated an IP address. After making the physical connection, small number of home networks may require the player's network setting to be adjusted.

Note

When plugging or unplugging the LAN cable, hold the plug portion of the cable. When unplugging, do not pull on the LAN cable but unplug while pressing down on the lock.

Do not connect a modular phone cable to the LAN port.

Since there are various connection configurations, please follow the specifications of your telecommunication carrier or internet service provider.

If you want to access content from PCs or DLNA servers, this player must be connected to the same local area network with them via a router.

Connecting to your Home Network

❖ Wired Network Connection

This player can be connected to a local area network (LAN) via the LAN port on the rear panel or the wireless device. By connecting the player to a broadband home network, you have access to service such as YouTube, Picasa and AccuWeather.

- ※ DP1W Model : Wi-Fi module is embedded for Wireless network connection.
- ※ DP1B Model : Wi-Fi dongle is required for Wireless network connection.

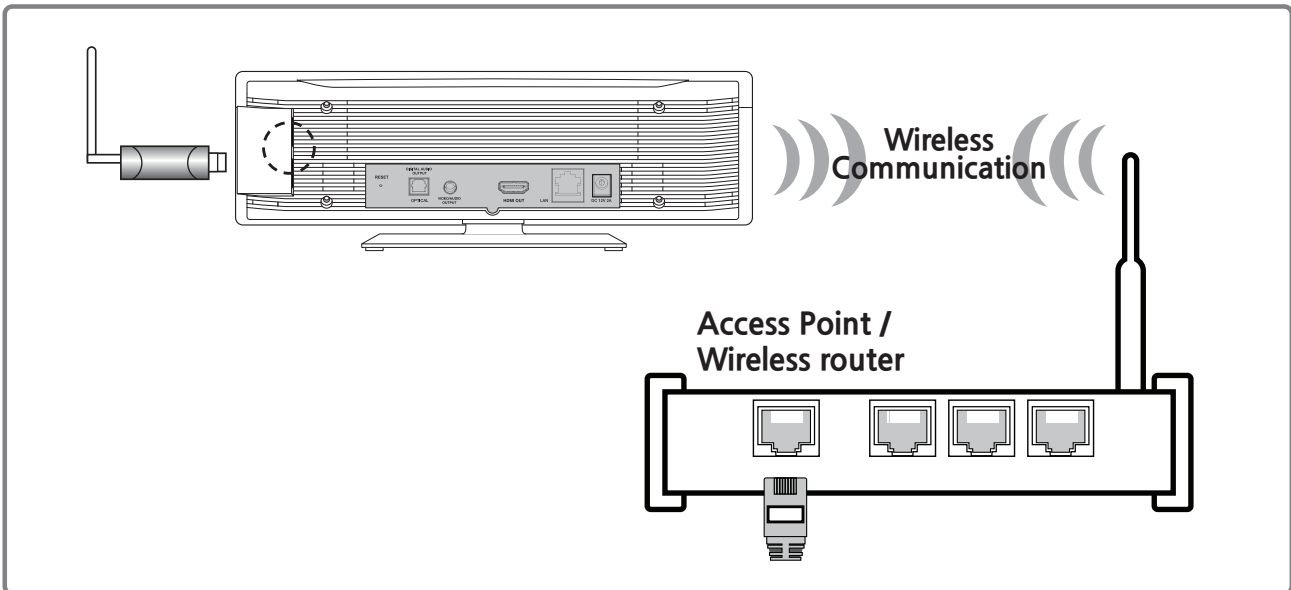

Another connection option is to use an Access Point or a wireless router. In the example configuration for wireless connection above, this player would be able to access content from either of the PCs.

The network configuration and connection method may vary depending on the equipment in use and the network environment.

This player is equipped with an IEEE 802.11n (2.4 GHz band only) wireless module, which also supports the 802.11b / g standards. For the best wireless performance, we recommend using a IEEE 802.11n certified Wi-Fi network (access point or wireless router).

Available Wi-Fi standards:

802.11b / 802.11g / 802.11n (single-band 2.4 GHz)

※ WPS PBC Mode

WPS : Wi-Fi Protect Setup

PBC : Push Button Connect

- Press PBC button on the Access Point / Wireless router to connect to player directly.
(Some of Access Point / Wireless routers do not have the PBC button.)
- First of all, proper wireless network setting is required.
- In the Wireless Network list, Press "Push Button" and the press PBC button on the Access Point / Wireless router, it will be directly connected in 2 minutes

For the wireless network connection, the player needs to be set up for network communication. This adjustment can be done from the [Setup] menu, Adjust the [Network] setting as follow. Setting up the access point or the wireless router is required before connecting the player to the network.

Wired internet connection is strongly recommended. Using the [Home Link] features, network update and video streaming services (such as, YouTube, Picasa and AccuWeather) with wireless network can be affected by the household devices using radio frequencies. The content of internet service and related service information, including user interface, is subject to change. Please refer to the web site of each service for updated information.

※ Note for DP1B Model

Wi-Fi Dongle is only compatible with pre-approved models listed on LG website.

(www.lg.com or www.lgservice.com)

Check LG website for compatibility before purchasing Wi-Fi dongle.

Connecting to your Home Network

❖ Notes on Network Connection

- ※ Many network connection problems during set up can often be fixed by re-setting the router or modem. After connecting the player to the home network, quickly power off and/or disconnect the power cable of the home network router or cable modem. Then power on and/or connect the power cable again.
- ※ Depending on the internet service provider (ISP), the number of devices that can receive internet service may be limited by the applicable terms of service. For details, contact your ISP.
- ※ Our company is not responsible for any malfunction of the player and/or the internet connection feature due to communication errors/malfunctions associated with your broadband internet connection, or other connected equipment.
- ※ The features of contents made available through the Internet Connection feature are not created or provided by our company, and our company is not responsible for their functionality or continued availability. Some contents related material available by the Internet Connection may not be compatible with this player. If you have questions about such content, please contact the producer of the content.
- ※ Some internet contents may require a higher bandwidth connection.
- ※ Even if the player is properly connected and configured, some internet contents may not operate properly because of internet congestion, the quality or bandwidth of your internet service, or problems at the provider of the content.
- ※ Some internet connection operations may not be possible due to certain restrictions set by the Internet service provider (ISP) supplying your broadband Internet connection.
- ※ Any fees charged by an ISP including, without limitation, connection charges are your responsibility.
- ※ A 10 Base-T or 100 Base-TX LAN port is required for wired connection to this player. If your internet service does not allow for such a connection, you will not be able to connect the player.
- ※ You must use a Router to use xDSL service.
- ※ A DSL modem is required to use DSL service and a cable modem is required to use cable modem service. Depending on the access method of and subscriber agreement with your ISP, you may not be able to use the internet connection feature contained in this player or you may be limited to the number of devices you can connect at the same time. (If your ISP limits subscription to one device, this player may not be allowed to connect when a PC is already connected.)
- ※ The use of a Router may not be allowed or its usage may be limited depending on the policies and restrictions of your ISP. For details, contact your ISP directly.
- ※ The wireless network operate at 2.4 GHz radio frequencies that are also used by other household devices such as cordless telephone, Bluetooth® devices, Microwave oven, and can be affected by interference from them.
- ※ Turn off all unused network equipment in your local home network. Some devices may generate network traffic.
- ※ For the purpose of the better transmission, placing the player from the access point as close as possible.
- ※ In some instances, placing the access point or wireless router at least 0.45 m (1.5 ft) above the floor may improve the reception.
- ※ Move closer to the access point if possible or re-orient the player so there is nothing between it and the access point.
- ※ The reception quality over wireless depends on many factors such as type of the access point, distance between the player and access point, and the location of the player.

Home Menu

❖ Home Menu

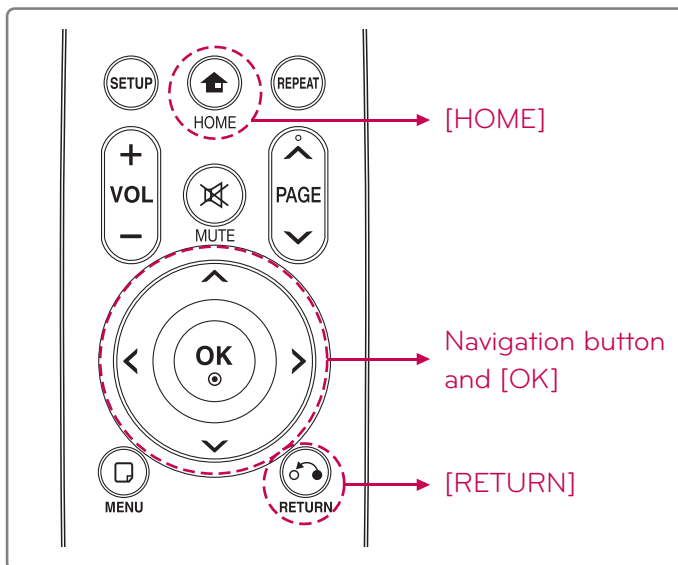

Home Menu

In Home Menu, use various Multimedia player's functions conveniently.

- Some of Menus are not activated without proper contents.
- If you press [HOME] during playing content, Home Menu is shown. (the played content is paused.)

1



HOME

Press [HOME].

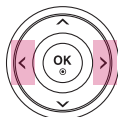

Select option using </>.

2



Press [OK]. Selected option or menu will be shown.

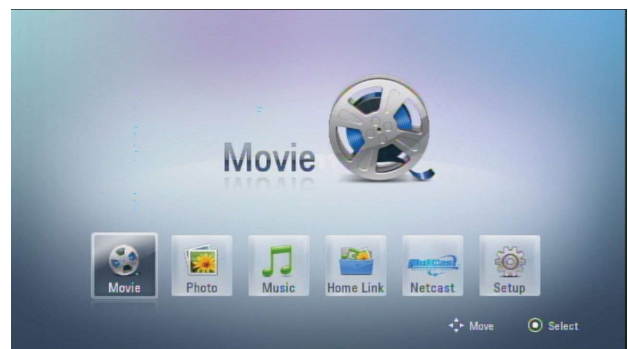

Movie : Display [Movie] Menu.

Photo : Display [Photo] Menu.

Music : Display [Music] Menu.

Home Link : Display Media Server Selection Menu.

NetCast : Display [Netcast] Menu.

Setup : Display [Setup] Menu.



※ Media Selection Menu.

When a USB Device or External Hard Disk Drive is connected on the product.

Media Selection Menu will be displayed.

Select the [USB1] or [USB2] option using </>, and press enter [OK].

Video / Audio Setting

❖ Digital Audio Output

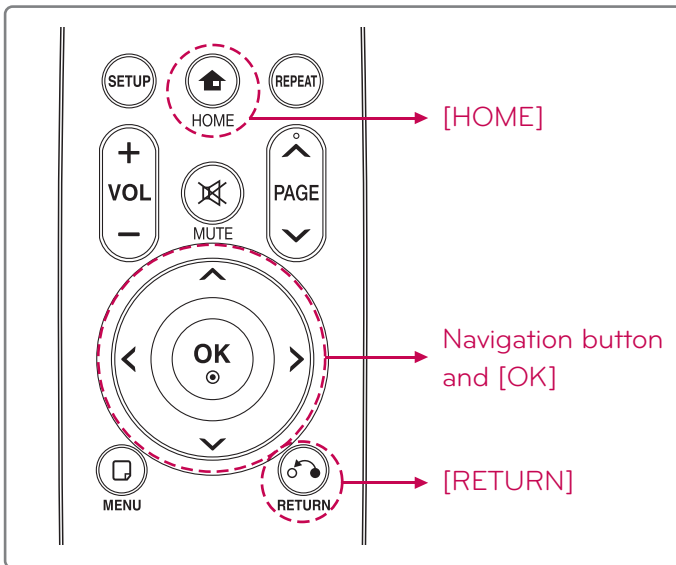

Digital Audio Output

Select the output sound format when a device equipped with a HDMI or Digital Audio input jack is connected to the HDMI out or Digital Audio jack on this player.

[PCM Stereo]

Select if you connect this unit's HDMI out or Digital audio out jack to a device with two-channel digital stereo decoder.

[Primary Pass-Thru]

Select if you connect this unit's Digital Audio Out and HDMI Out jack to a device with LPCM, Dolby digital, DTS decoder.

- If the audio format of the digital output does not match the capabilities of your receiver, the receiver will produce a strong, distorted sound or no sound at all.

1



HOME

Press [HOME].

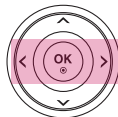

Move to [SETUP] and press [OK].

2



Move to [VIDEO / AUDIO].

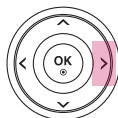

Go to next step.

3



Go to [SPDIF].

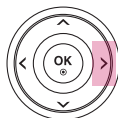

Go to next step.

4

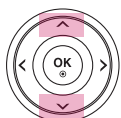

Select option using ^ / v.



Press [OK] for confirmation.

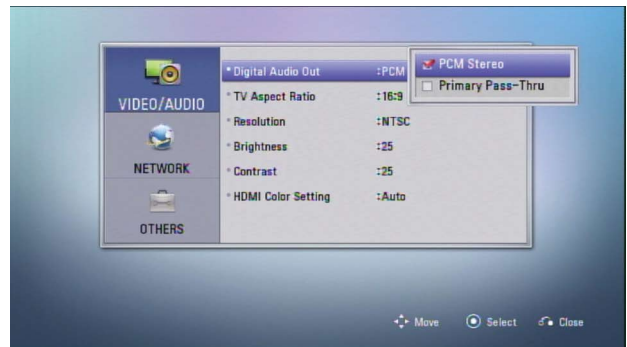

※ Caution

- If you select [Primary Pass-Thru] for [Digital Audio Output], This player cannot support to increase / decrease the volume of Dolby Digital (AC3) and DTS audio format.
- To increase / decrease the volume, control the volume of Amplifier.



HOME



RETURN

Press [HOME] or [RETURN] to exit menu or cancel the selection.

❖ Audio Output Specifications

Jack / Setting Audio Source	Analog Audio Out	Digital Audio Out (HDMI / SPDIF)	
		PCM Stereo	Primary Pass-thru
Dolby Digital (5.1 Ch)	PCM 2 Ch	PCM 2 Ch	Dolby Digital (5.1 Ch)
Dolby Digital Plus (7.1 Ch)	PCM 2 Ch	PCM 2 Ch	Dolby Digital (5.1 Ch)
Dolby TrueHD (7.1 Ch)	PCM 2 Ch	PCM 2 Ch	Dolby Digital (5.1 Ch)
DTS (5.1 Ch)	PCM 2 Ch	PCM 2 Ch	DTS (5.1 Ch)
DTS-HD (7.1 Ch)	PCM 2 Ch	PCM 2 Ch	DTS (5.1 Ch)
Linear PCM 2 Ch	PCM 2 Ch	PCM 2 Ch	PCM 2 Ch
Linear PCM 5.1 Ch	PCM 2 Ch	PCM 2 Ch	PCM 2 Ch
Linear PCM 7.1 Ch	PCM 2 Ch	PCM 2 Ch	PCM 2 Ch
Multi-Channel analog	PCM 2 Ch	PCM 2 Ch	No Sound

1. The secondary and interactive audio may not be included in the output bitstream if [Digital Output] or [HDMI] option is set to [Primary Pass-Thru]. (Except LPCM Codec : the output always include interactive and secondary audio.)
2. [Primary Pass-thru] does not support Multi-Channel analog audio source. (the sound may not be heard through SPDIF or HDMI.) Please set to [PCM Stereo] for Multi-Channel analog audio source.
3. If the Audio format of the digital output does not match the capabilities of your receiver, the receiver will produce a strong, distorted sound or no sound at all.

Video / Audio Setting

❖ Digital Audio Output

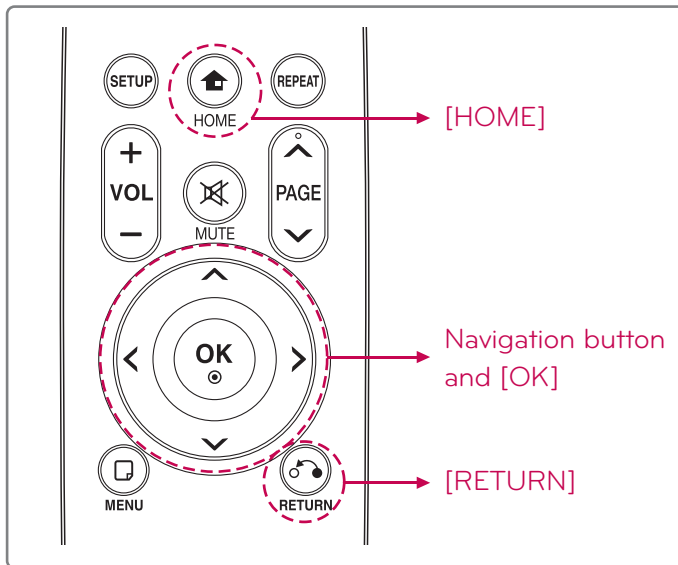

TV Aspect Ratio

Select a TV aspect ratio option according to your TV type.

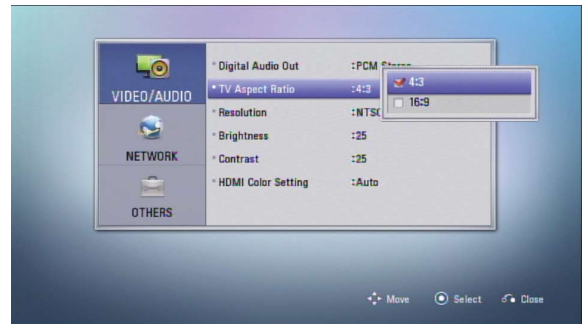

- 1**

Press [HOME].

Move to [SETUP] and press [OK].
 - 2**

Move to [VIDEO / AUDIO].

Go to next step.
 - 3**

Go to [TV Aspect Ratio].

Go to next step.
 - 4**

Select option using \wedge / \vee .

Press [OK] for confirmation.
- HOME RETURN
- Press [HOME] or [RETURN] to exit menu or cancel the selection.

TV Aspect Ratio	4 : 3 TV / Monitor	
	4 : 3 Photo / Video	16 : 9 Photo / Video
4 : 3		
16 : 9		

TV Aspect Ratio	16 : 9 TV / Monitor	
	4 : 3 Photo / Video	16 : 9 Photo / Video
4 : 3		
16 : 9		

Video / Audio Setting

❖ Resolution

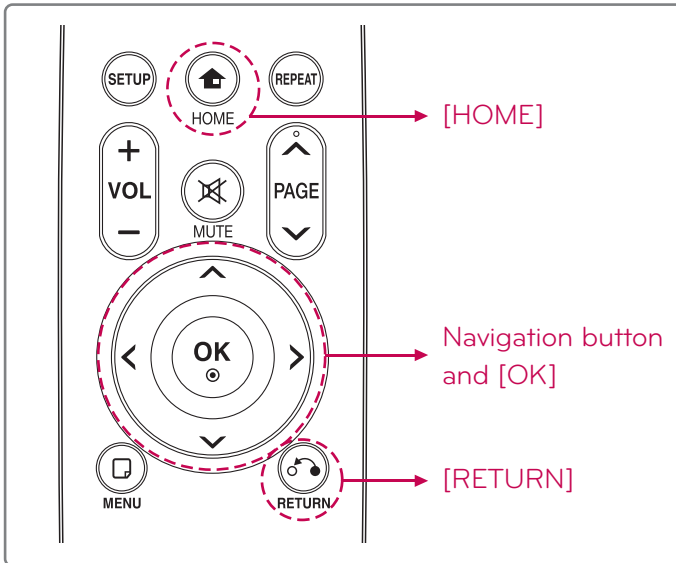

Resolution

Sets the output resolution of the Composite and HDMI video signal

- If you select a resolution that your TV does not accept, the warning message or abnormal screen will appear.
- If you select a resolution manually and then connect the HDMI jack to TV and your TV does not accept it, the resolution setting is set to [Auto].
- For more detail resolution information, please see the next page.

1



HOME

Press [HOME].

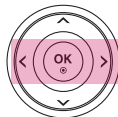

Move to [SETUP] and press [OK].

2



Move to [VIDEO / AUDIO].

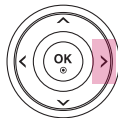

Go to next step.

3

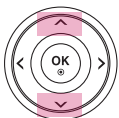

Go to [Resolution].

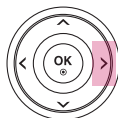

Go to next step.

4

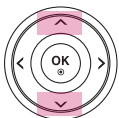

Select option using \wedge / \vee .

» Auto, 480i, 480p, 720p, 1080i, 1080p



Press [OK] for confirmation.



HOME



RETURN

Press [HOME] or [RETURN] to exit menu or cancel the selection.

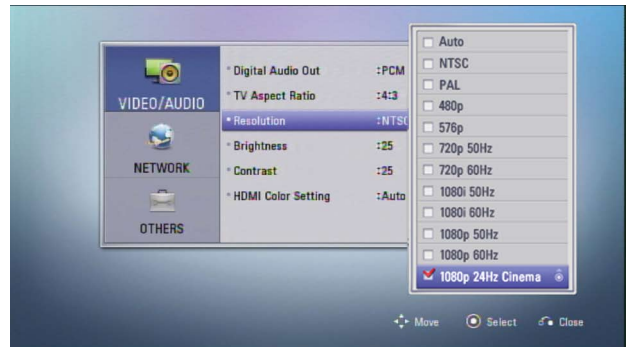

❖ Resolution Setting

Resolution Type

- Auto : If the HDMI OUT jack is connected to TV's providing display information (EDID), automatically selects the resolution best suited to the connected TV.
- NTSC : Outputs 480 lines of interlaced video. (60 Hz)
- PAL : Outputs 576 lines of interlaced video. (50 Hz)
- 480p : Outputs 480 lines of progressive video. (60 Hz)
- 576p : Outputs 576 lines of progressive video. (50 Hz)
- 720p 50 Hz : Outputs 720 lines of progressive video. (50 Hz)
- 720p 60 Hz : Outputs 720 lines of progressive video. (60 Hz)
- 1080i 50 Hz : Outputs 1080 lines of interlaced video. (50 Hz)
- 1080i 60 Hz : Outputs 1080 lines of interlaced video. (60 Hz)
- 1080p 50 Hz : Outputs 1080 lines of progressive video. (50 Hz)
- 1080p 60 Hz : Outputs 1080 lines of progressive video. (60 Hz)
- 1080p 24 Hz : When the resolution is set to 1080p, select [24 Hz] for smooth presentation of film material (1080p / 24 Hz) with a HDMI-equipped display compatible with 1080p / 24 Hz input.

HDMI / Video out connection

HDMI out Connection

- Auto, 1080p, 1080i, 720p, 576p, 480p is available.
- If you select a resolution manually and then connect the HDMI jack to TV and your TV does not accept it, the resolution setting is set to [Auto].

Video out connection

- The resolution of the Video out jack is always outputted at NTSC or PAL resolution.

The optimized mode for TV

The optimized mode for PAL TV's and NTSC TV's is 50 Hz and 60 Hz, respectively.

- Choosing the wrong frequency mode(50 Hz or 60 Hz) can cause the screen to shake during movie or picture playback.

- This product supports HDMI out and A/V out simultaneously.
- HDMI or HDCP capable DVI input on your display device is required for some content.

This 1080p video output frame rate may be automatically set to either 24 Hz or 60 Hz depending both on the capability and preference of the connected TV and based on the native video frame rate of the content.

- When you select [24 Hz], you may experience some picture disturbance when the video switches video and film material. In this case, select [60 Hz].
- Even when [1080p Display Mode] is set to [24 Hz], if your TV is not compatible with 1080p / 24 Hz, the actual frame frequency of the video output will be 60 Hz to match the video source format.

Video / Audio Setting

❖ Brightness | Contrast

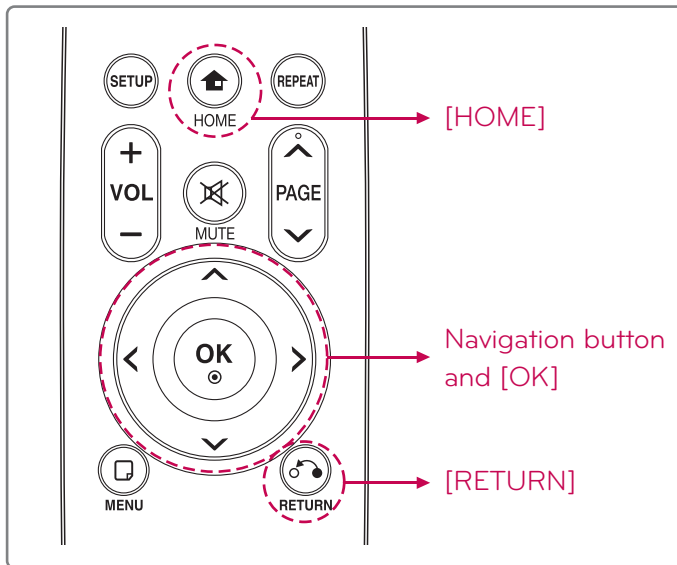

Brightness / Contrast

Sets the Brightness / Contrast level of the Composite and HDMI video signal

· Brightness / Contrast level range is 0 to 50.

- 1**

HOME
Press [HOME].

Move to [SETUP] and press [OK].
 - 2**

Move to [VIDEO / AUDIO].

Go to next step.
 - 3**

Go to [Brightness] or [Contrast]

Go to next step.
 - 4**

Select option using \wedge / \vee .

Press [OK] for confirmation.
- HOME RETURN

 Press [HOME] or [RETURN] to exit menu or cancel the selection.

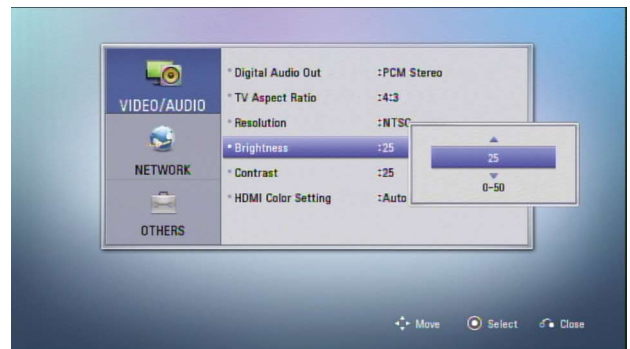

Video / Audio Setting

❖ HDMI Color Setting

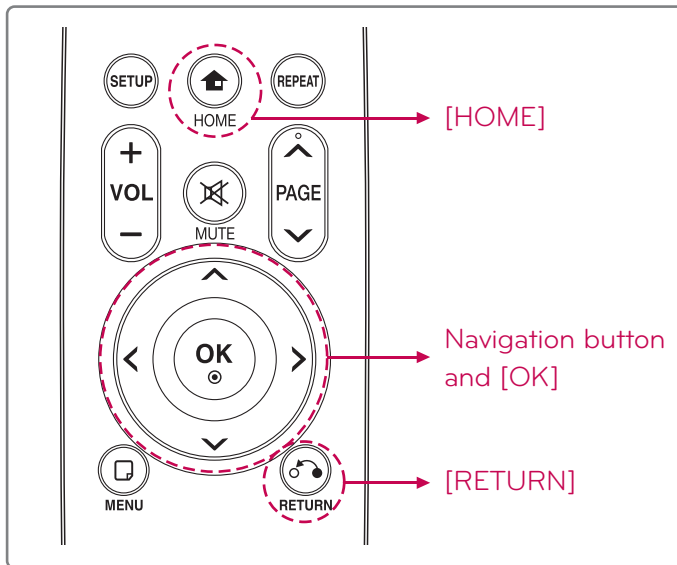

HDMI Color Setting

Select the type of output from the HDMI OUT jack. For this setting, please refer to the manuals of your display device.

- YCbCr : Select when connect to HDMI display device.
- RGB : Select when connect to DVI display device.
- Auto : Automatically selects the HDMI Color Setting

- 1

HOME

Press [HOME].

Move to [SETUP] and press [OK].
- 2

Move to [VIDEO / AUDIO].

Go to next step.
- 3

Go to [HDMI Color Setting].

Go to next step.
- 4

Select option using \wedge / \vee .
» YCbCr, RGB

Press [OK] for confirmation.

HOME RETURN

Press [HOME] or [RETURN] to exit menu or cancel the selection.

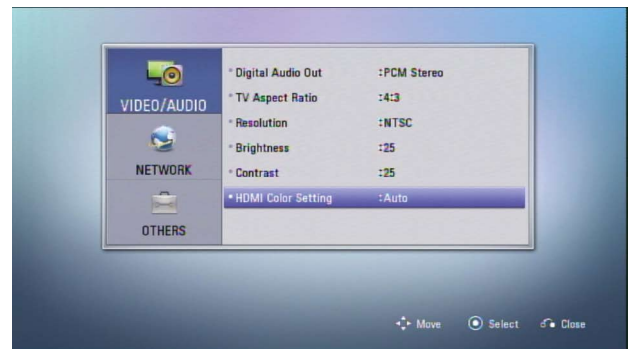

Network Setting

❖ Connection Setting

Wired network Setting

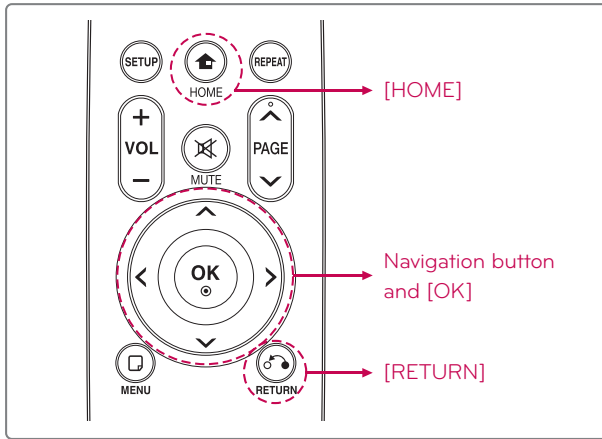

By connecting the unit to a broadband home network, you have access to services such as Home Link and NetCast

- Using a wired network provides the best performance, because the attached devices connect directly to the network and are not subject to radio frequency interference.
- Before setting the wired network, you need to connect the broadband internet to your home network.

Choose [Network] → [Connection setting] and press [OK]

1) Dynamic Mode

1

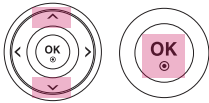

Select [Wired] and press [OK].

2

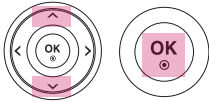

Select IP mode [Dynamic] and press [OK].
» Press [OK] to complete the network connection.

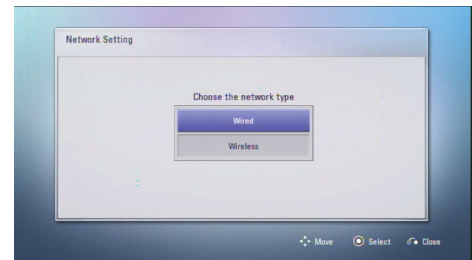

2) Static Mode

1

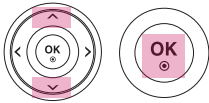

Select [Wired] and press [OK].

2

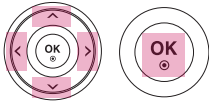

Select IP mode [Static] and press [OK].
Set [IP Address], [Subnet Mask], [Gateway] and [DNS Server].
<- : Deletes the character.
<< : Move to previous block.
>> : Move to next block.
» Press [OK] to complete the network connection.



Press [HOME] or [RETURN] to exit menu or cancel the selection.

Note

If there is no DHCP server on the network and you want to set the IP address manually, select [Static] then set [IP Address], [Subnet Mask], [Gateway] and [DNS Server] using </>/^/∨ buttons.

Network Setting

❖ Connection Setting

Wireless network setting

For the wireless network connection, the player needs to be set up for network communication. This adjustment can be done from the [Setup] menu. Setting up the access point or the wireless router is required before connecting the player to the network.

Choose [Network] → [Connection setting] and press [OK].

1) Dynamic Mode

1

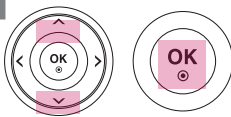

Select [Wireless] and press [OK].

2

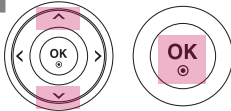

Select an access point or wireless router on the list, and then press [OK].

- » The player scans the all available access points or wireless routers within range and display them as a list.
- » If you have security on your access point or wireless router, you need to input the security code as necessary.
- » Press [OK] to complete the network connection.

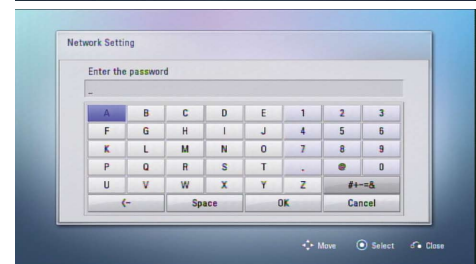

※ Push Button

If your access point or wireless router that supports the Push Button Configuration method, select this option and press the Push Button on your access point or wireless router within 120 counts. You do not need to know the access point name (SSID) and security code of your access point or wireless router.

※ Favorite

The last network connection information will be stored automatically in favorite list. (If there is no network connection information, favorite list is not activated.)

If you connect network in favorite list, Network ID and password are not required.

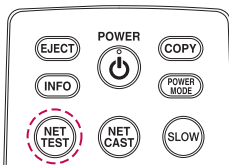

Press [NET TEST] to scan the all available access point or wireless routers in [Connection Setting] Menu.

※ WPS PBC Mode

WPS : Wi-Fi Protect Setup

PBC : Push Button Connect

- Press PBC button on the Access Point / Wireless router to connect to player directly. (Some of Access Point / Wireless routers do not have the PCB button.)
- First of all, proper wireless network setting is required.
- In the Wireless Network list, Press "Push Button" and the press PCB button on the Access Point / Wireless router, it will be directly connected in 2 minutes



Press [HOME] or [RETURN] to exit menu or cancel the selection.

Network Setting

❖ Connection Setting

Wireless network setting

2) Manual Mode

1

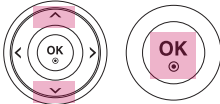

Select [Wireless] and press [OK].

2

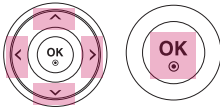

Select [Manual] and press [OK]. Manually enter the access point name (SSID) and then select [OK] and press [OK].

3

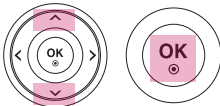

Choose a security for wireless network and press [OK].
 » Selectable option (No Security, WEP, WPA-PSK TKIP, WPA-PSK AES, WPA2-PSK TKIP, WPA2-PSK AES)

4

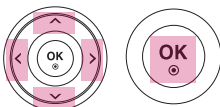

Input the password for wireless network. Select [OK] and press [OK].
 » If you choose [No Security] for previous step, you do not need to input the password.

5-1

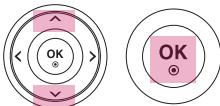

Select IP mode [Dynamic] and press [OK].
 » Press [OK] to complete the network connection.

5-2

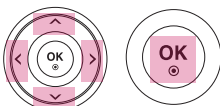

Select IP mode [Static] and press [OK]. Set [IP Address], [Subnet Mask], [Gateway] and [DNS Server].
 <- : Deletes the character.
 << : Move to previous block.
 >> : Move to next block.
 » Press [OK] to complete the network connection.

Note

If there is no DHCP server on the network and you want to set the IP address manually, select [Static] then set [IP Address], [Subnet Mask], [Gateway] and [DNS Server] using </>/^/∨ buttons.

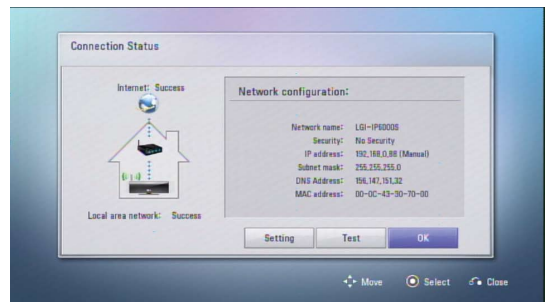
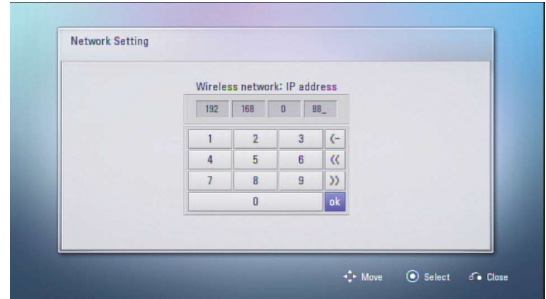

Press [HOME] or [RETURN] to exit menu or cancel the selection.

Network Setting

❖ Connection Status

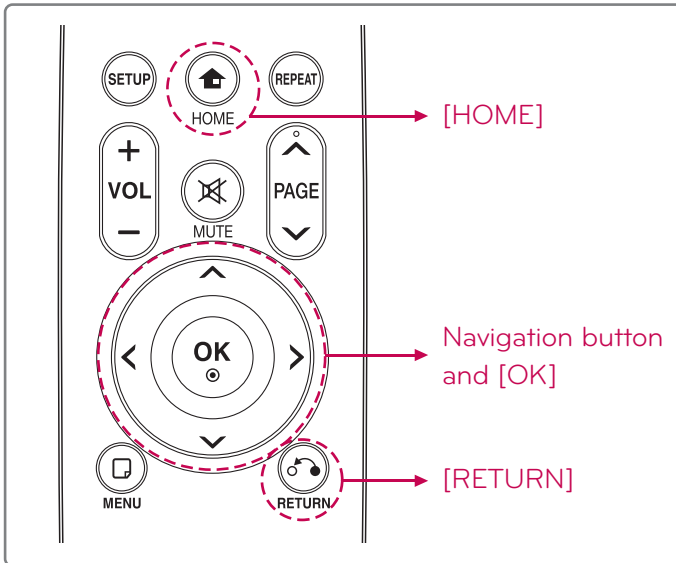

Connection Status

Current network connection status will be displayed.

- 1**



HOME

Press [HOME].

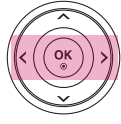

Move to [SETUP] and press [OK].
 - 2**



Move to [Network].



Go to next step.
 - 3**





Go to [Connection Status].

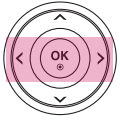

Press [OK] to go to next step.
 - 4**



Select the option you want and press [OK].

 - » Setting : Go to [Connection setting] menu.
 - » Test : Select to test network connection
 - » OK : Select for confirmation.
- 

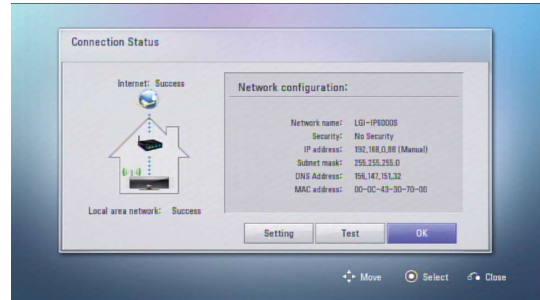
 Press [HOME] or [RETURN] to exit menu or cancel the selection.

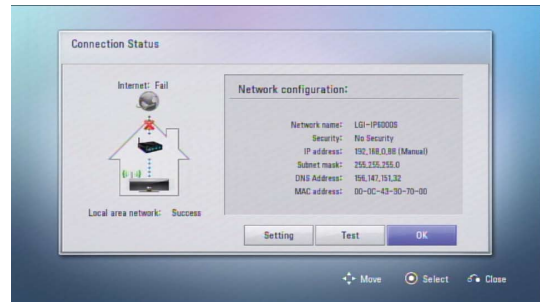

<Internet : Success, Network : Connected>

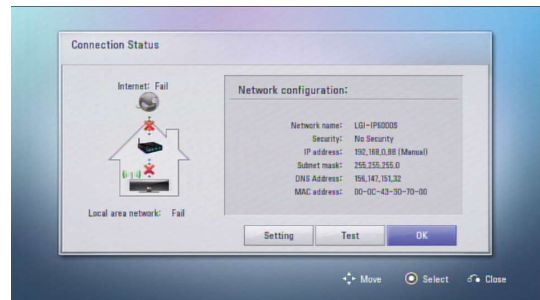

<Internet : Fail, Network : Connected>



<Internet : Fail, Network : Disconnected>

Network Setting

❖ Device Name

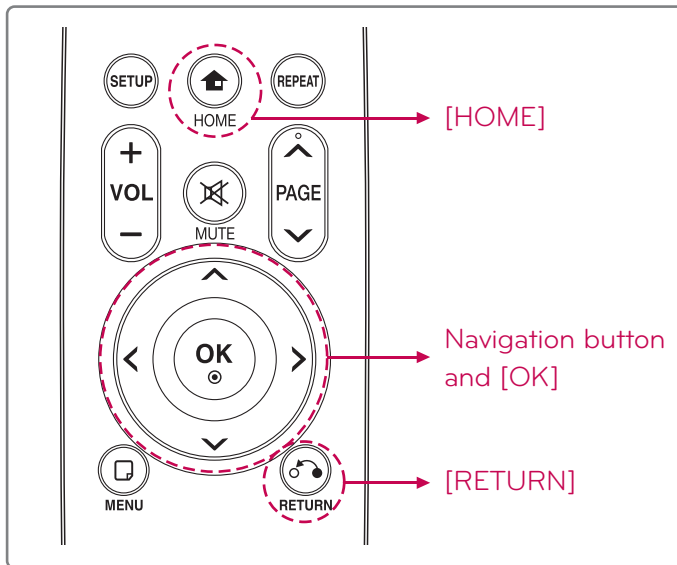

Access Device Name

Select to change or re-name device name.

· Default Device name is LG DP1.

- 1**

HOME
Press [HOME].

Move to [SETUP] and press [OK].
- 2**

Move to [Network].

Go to next step.
- 3**

Go to [Device Name].

Press [OK] to go to next step.
- 4**

Change the Device name and press [OK] for confirmation.

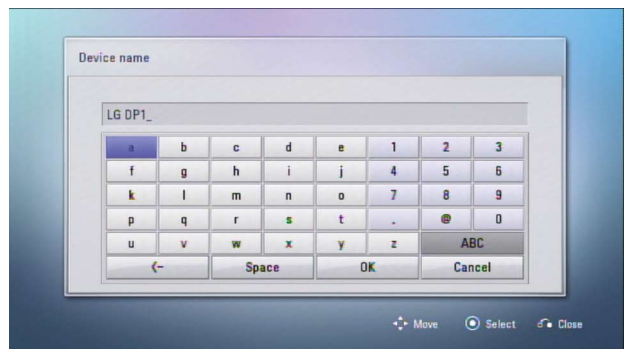

Press [HOME] or [RETURN] to exit menu or cancel the selection.

Network Setting

❖ Sharing on Network | Auto Login | Clear Login Information

Sharing on Network | Auto Login | Clear Login Information

Depending on your PC's environment, you may need to enter a network user ID and the password for accessing a shared folder. The network user ID and password will be remembered after accessing the folder for your convenience. If you do not want the network user ID and password to be remembered.

- 1**



HOME
Press [HOME].

Move to [SETUP] and press [OK].
- 2**



Move to [Network].

Go to next step.
- 3**



Go to [Sharing on Network], [Auto Login] or [Clear Login Information].

Press [OK] to go to next step.
- 4**



Select option and press [OK] for confirmation



<Sharing on Network>



<Auto Login>



<Clear Login Information>

❖ Disclaimer Notice

For more detail information, please see the [Important information relating to network services] chapter.
In the menu, select [Disclaimer Notice] and press [OK] to see the notice.



Press [HOME] or [RETURN] to exit menu or cancel the selection.

Others Setting

❖ Menu Language Setting

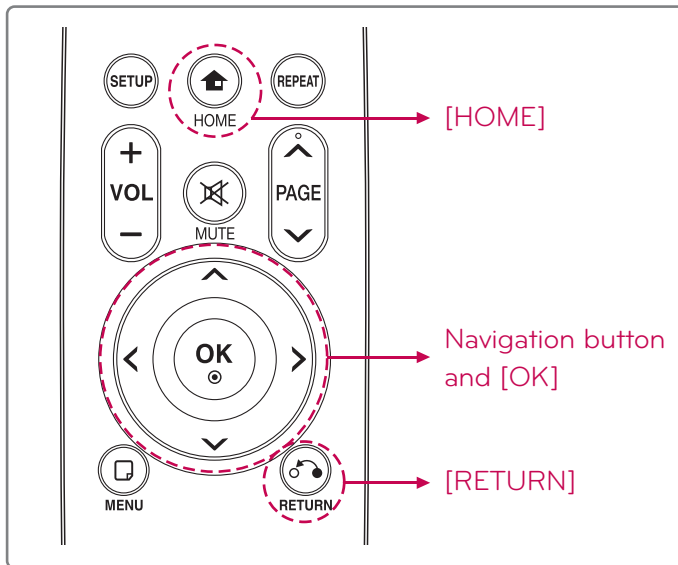

Menu Language

Select to choose the OSD (On Screen Display) language.

- 1**

Press [HOME].

Move to [SETUP] and press [OK].
 - 2**

Move to [Others].

Go to next step.
 - 3**

Go to [Menu Language].

Press [OK] to go to next step.
 - 4**

Select the menu language.

Press [OK] for confirmation.
- HOME RETURN
- Press [HOME] or [RETURN] to exit menu or cancel the selection.



- Korean : Select to choose the Korean Language.
 - English : Select to choose the English Language.
- French, German, Polish, Portuguese, Spanish, Italian, Dutch, Russian, Turkish, Greek, Chinese, Japanese are supported.
(Depending on the region, supported GUI language may change.)

Others Setting

❖ DivX VOD

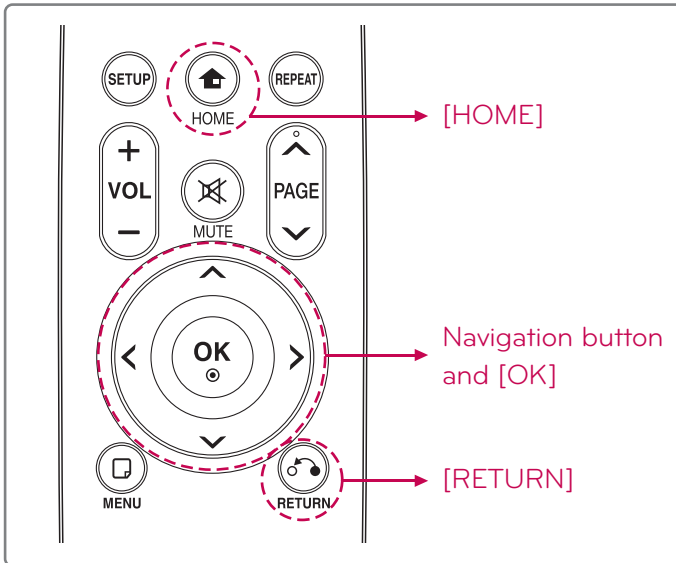

DivX Register / Deregister

DivX Register is required to play DivX formatted (Encoding) video file.

For more DivX register and deregister information, please visit www.divx.com

1



HOME

Press [HOME].



Move to [SETUP] and press [OK].

2

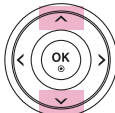

Move to [Others].



Go to next step.

3



Go to [DivX VOD].



Press [OK] to go to next step.

4

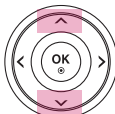

Register or Deregister DivX



Press [OK] for confirmation.



Press [HOME] or [RETURN] to exit menu or cancel the selection.



Others Setting

❖ Power Mode

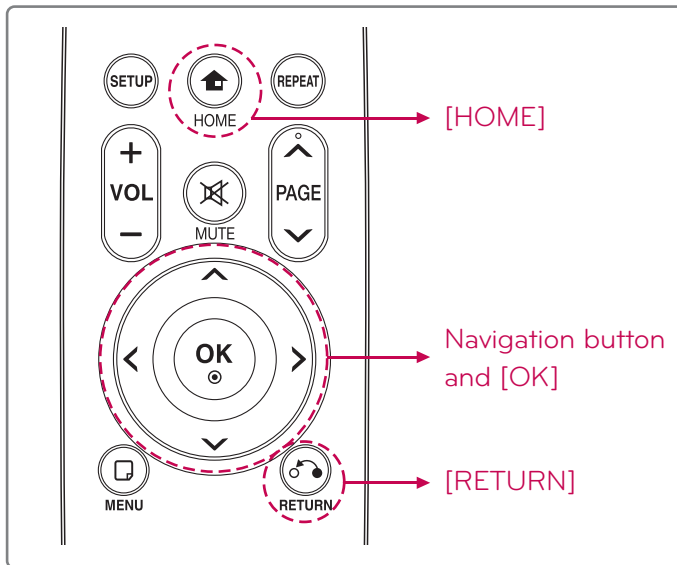

Power Mode

Select to change the power mode.
[Power Off] → [Network] → [Check Mode]

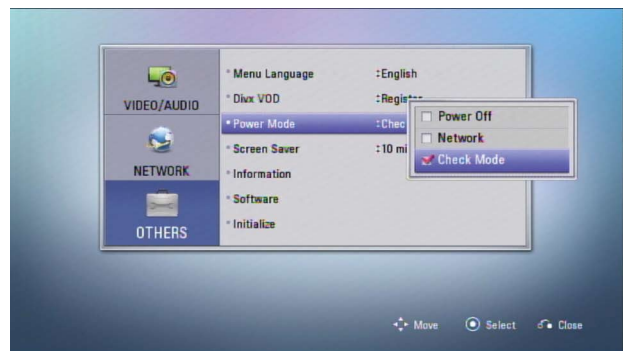
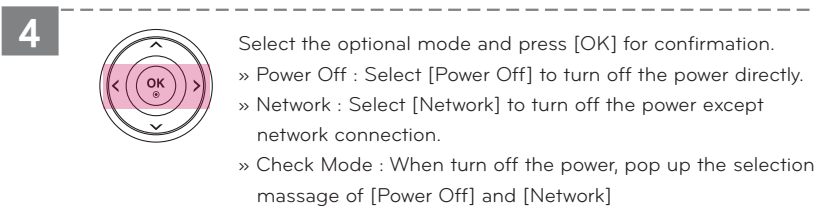
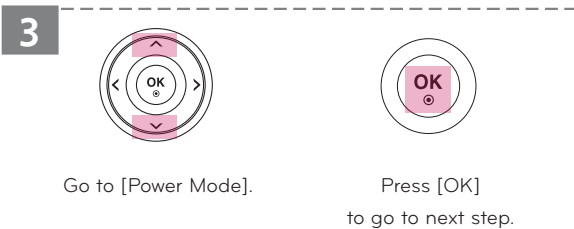
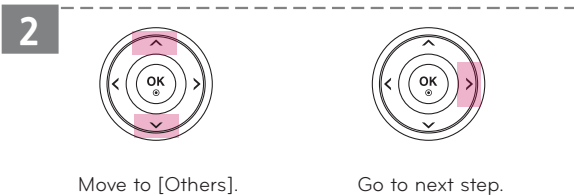

Press [HOME] or [RETURN] to exit menu or cancel the selection.

Others Setting

❖ Screen Saver

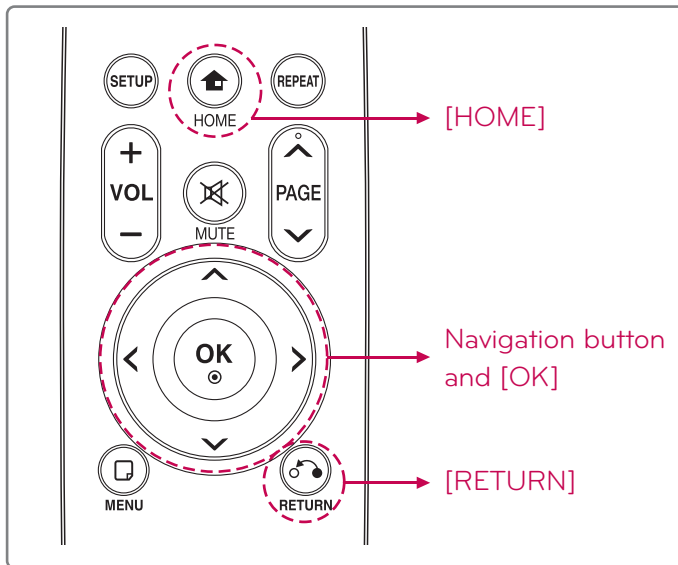

Screen Saver

Select to change the time and image of screen saver.

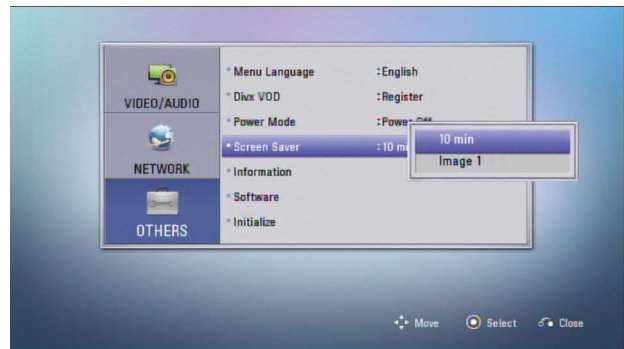
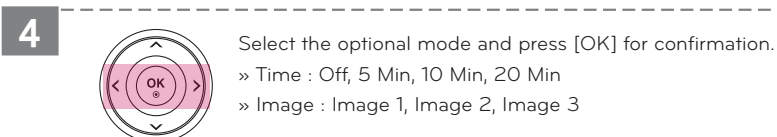
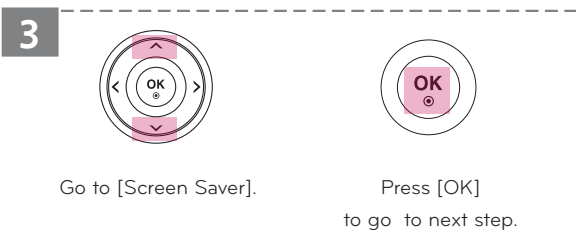
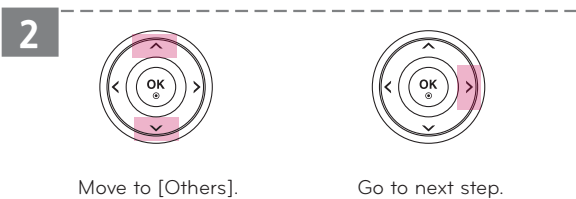

Press [HOME] or [RETURN] to exit menu or cancel the selection.

Others Setting

❖ Information | Initialize

Information

Display the information (Capability, Network Status, etc) of connected USB Storage device.

Move to [OTHERS] → [Information], and press [OK].

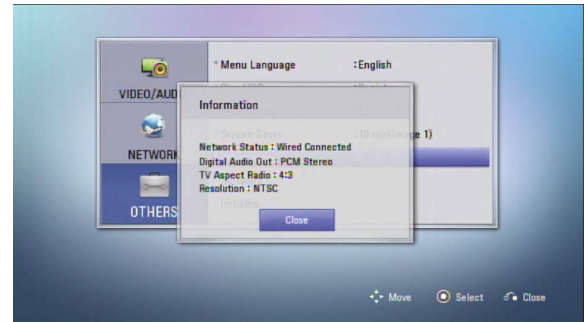

- USB Capacity : Display the capacity of USB Storage device
- Network Status : Display network status (Wired or wireless)
- IP Address, MAC Address, Software Version.

Initialize

You can reset the player to its original factory settings.

Move to [OTHERS] → [Initialize], and press [OK].

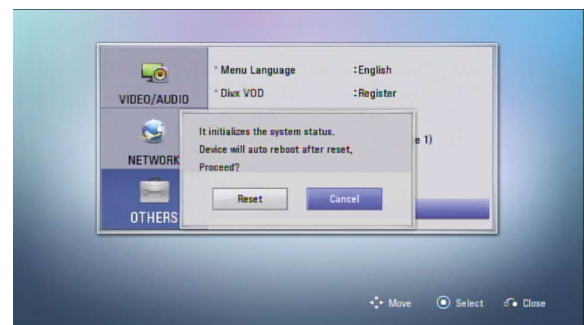

- [Reset] Button on the rear of the unit can reset to its original factory settings as well.
- If you reset the player to its original factory settings using [Initialize] option, you have to set the network settings, all the activations in the NetCast again.



HOME



RETURN

Press [HOME] or [RETURN] to exit menu or cancel the selection.

❖ Software (Firmware Upgrade)

Software

You can update the player using the latest software to enhance the products operation and/or add new features. To download the new firmware, please visit (www.lg.com or www.lgservice.com).

1

Connect the USB storage drive with downloaded new firmware.
Place the firmware file in the root directory.
Ex) D:₩, E:₩

2

Move to [OTHERS] → [Software] → [Update] and then press [OK].

3

The player will check for the newest update. If newer version exists, the popup message appears. Select [OK] to download the update.
(Selecting [Cancel] will end the update.)

4

When update is completed, power will turn off automatically. Turn the power back on. The system now operates with the new version.

· Do not turn off the power during the software update.

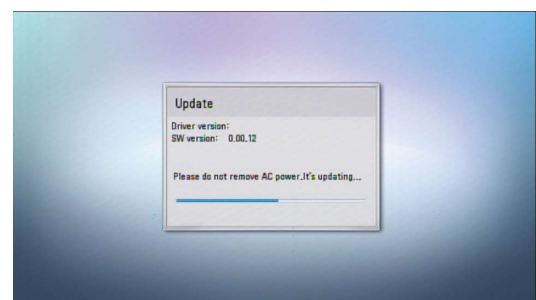
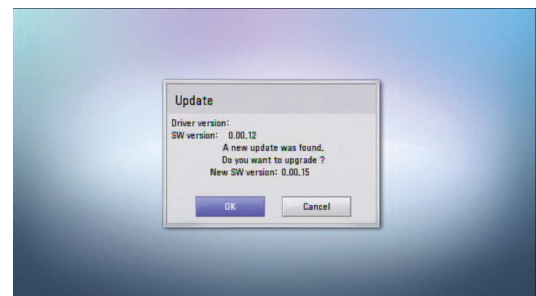
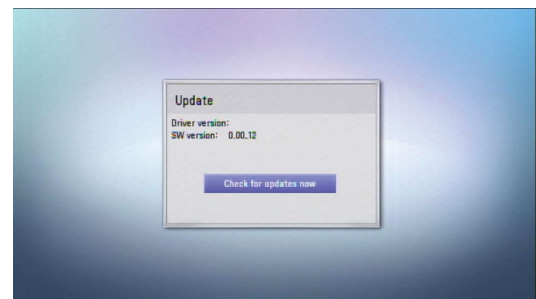
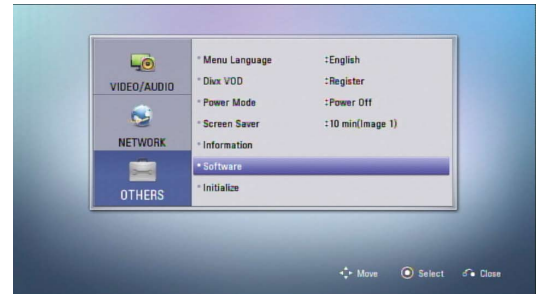

HOME



RETURN

Press [HOME] or [RETURN] to exit menu or cancel the selection.

USB Device Connection

❖ USB Device Connection

USB Device Connection

Playback content in the USB storage device

· For more detail information of playing, please see the [Playing a video file], [Viewing a Photo file] and [Listening to music] chapter.

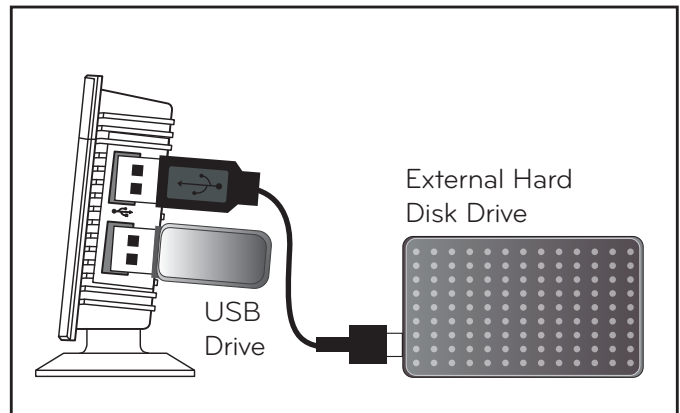

1

Insert a USB device to the USB port until it fits into place.
» File loading may take a few minutes depending on the number of content stored in the USB storage device. Press [OK] while [Cancel] is selected to stop loading.



2



In [Home] Menu, choose [Movie], [Music] or [Photo] menu and press [OK].



3



Select [USB1] or [USB2] and press [OK].

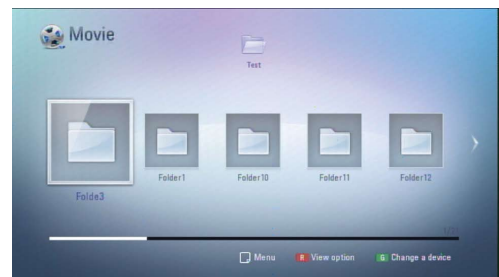

4

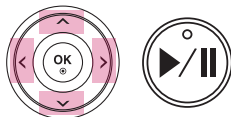

Press [PLAY / PAUSE] after selecting file wants to play.

USB Device Connection

❖ Caution During Using USB Device

Using USB Device

Caution during using USB device	
Compatibility	A USB device which requires additional program installation when you have connected it to a computer, is not supported.
	USB device: USB storage device that supports USB 1.1 and USB 2.0.
	This player supports USB flash memory/external HDD formatted in FAT16, FAT32 and NTFS when accessing files (music, photo,movie).
Note	<ul style="list-style-type: none">※ This unit can support up to 4 partitions of the USB device. Movie, music and photo files can be played.※ For details of operations on each file, refer to relevant pages.※ Regular back up is recommended to prevent data loss.※ If you use a USB extension cable, USB HUB or USB Multi-reader, the USB device may not be recognized.※ Some USB device may not work with this unit.※ Digital camera and mobile phone are not supported.※ USB Port of the unit cannot be connected to PC.※ The unit cannot be used as a storage device.

File Setting

❖ File Information | File Search

File Information

The player can display the content information.

1

Connect the USB storage device to the player.

2

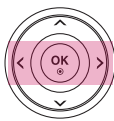

In [HOME] menu, select [MOVIE] menu and press [OK].

3

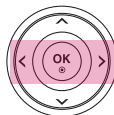

Select [USB 1] or [USB 2] and press [OK].

4

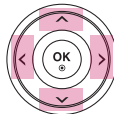

Select the file to see the file information.

5

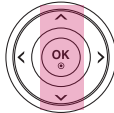

Press [MENU] and select [Information] sub menu. Press [OK] to see the file information.

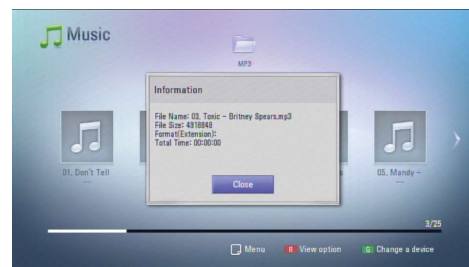

File Search

Searching content in the external hard disk drive or USB Storage device by entering file name.

1

In the folder [Movie, Music or Photo menu], press [SEARCH].

2

Select Media type (All, photo, video or music) and then select Search type (contains or start with).

3

Select letters on virtual keyboard and press [OK] to display the search result.











File Setting

❖ File Copy

File Copy

You can copy music, photo, video file(s) / folder(s) from USB storage device to another USB storage device.

· Copying speed may vary depending on the file size, number of files and network condition.

- 1 Connect USB storage devices to corresponding USB ports of this product.
- 2   In [HOME] menu, select [MOVIE] menu, [PHOTO] or [MUSIC], and press [OK].
- 3  Select the USB storage device you want to copy and, press [OK].
- 4   Press [Menu] to display the option menu. Select [COPY] option, and press [OK] to display the [COPY] Menu.
- 5  Select a file or a folder you wish to copy on the menu, and press [OK].
- 6  Select [Copy], and press [OK].
- 7  Select the destination folder to be copied.
- 8  Select [OK], and press [OK] to start copying. (Pop-up window will be shown. To cancel copying files, Select [Cancel], and press [OK].)
- 9  After completion of copying, press [Return] twice.

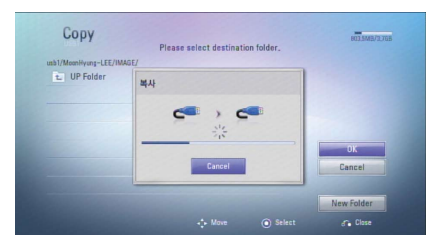
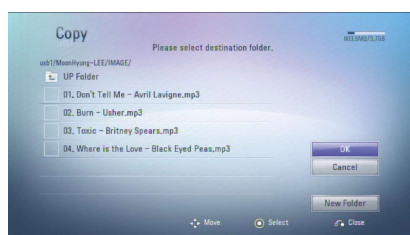
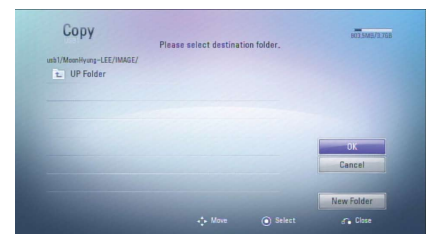
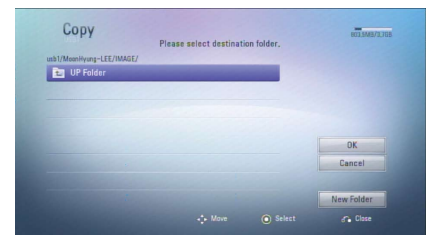
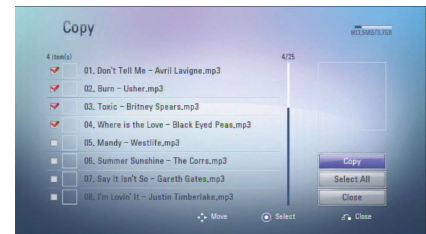
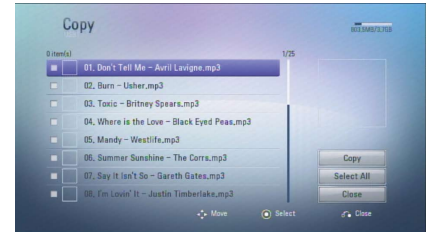

File Setting

❖ File Rename

File Rename

You can re-name a file (Movie, music and photo) or folder in the USB Storage Device.

1



MENU

In [MOVIE], [MUSIC] or [PHOTO] Menu, press [MENU] to display the option menu.

2

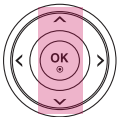

Select [Rename], and press [OK] to display the virtual keyboard.

3



Enter a new name using virtual keyboard.

4



press [OK] while [OK] in virtual key board is selected.
» Selected file or folder name is changed.

<- : Deletes the previous character at the cursor position.

Space : Inserts a space at the cursor position.

abc / ABC / #+--=& : Changes the virtual keyboard setting to capital letters, small letters or symbols.

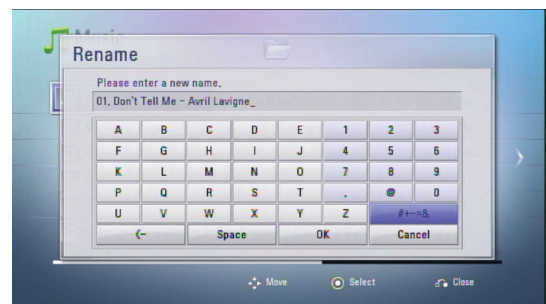
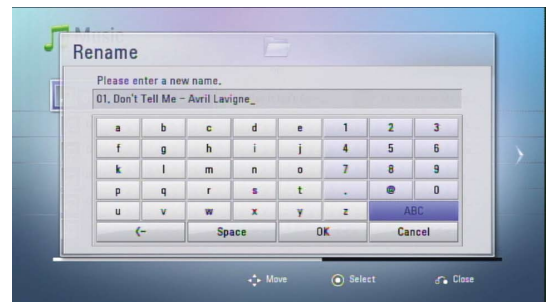
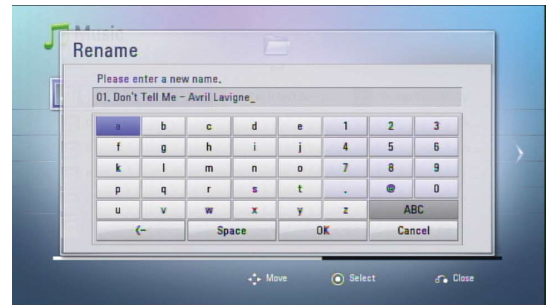

File Setting

❖ File Delete

File Delete

You can delete a file (Movie, music and photo) or folder in the USB Storage Device.

1



In [MOVIE], [MUSIC] or [PHOTO] Menu, press [MENU] to display the option menu.

2

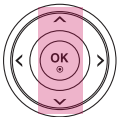

Select [Delete], and press [OK].
» [Delete] Menu will be displayed.

3

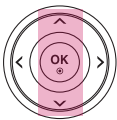

Select a file or a folder you wish to delete, and press [OK].
» Selected files or folders will be shown on the list.
» To select all of files and folders, press [OK] while [Select All] is selected.
» To go to upper menu, press [OK] while [Close] is selected.

4



Select [Start], and press [OK].
Press [OK] while [YES] is selected.
After completion of deleting, press [Return].

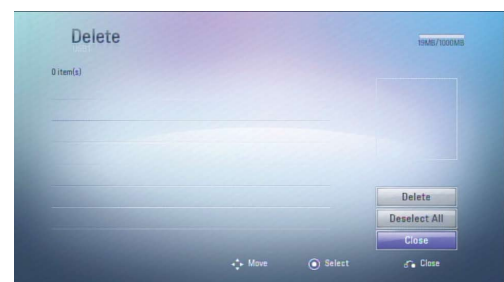
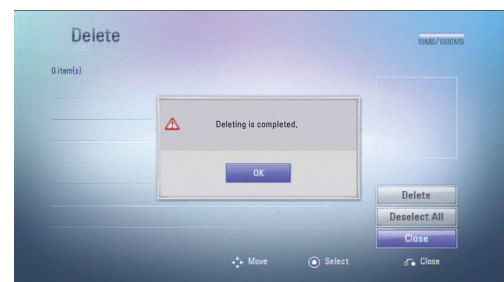
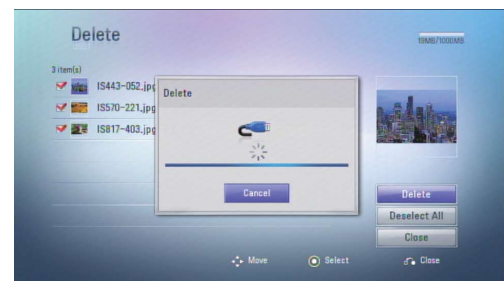
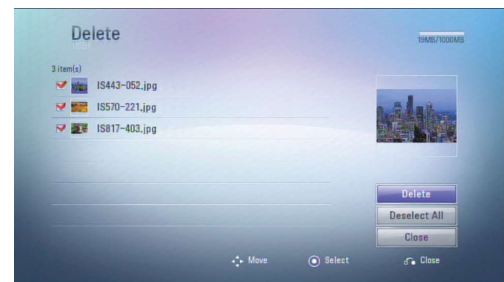
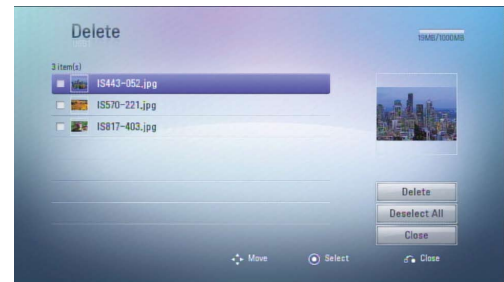

Playing a Video File

❖ General Playback | Using colored buttons (R, G, Y, B)

You can play various format video files contained in a USB Drive and External Hard Disk Drive.

· To see the file information (Video codec, Audio codec, File running time), press [INFO] after selecting the file.

General Playback

1

Connect USB Drive or External Hard Disk Drive to Multimedia Player.

2

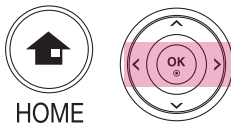

Press [HOME], Select [Movie] using < / >, and Press [OK].

3

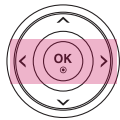

Select [USB 1] or [USB 2] option using < / >, and press [OK].

4

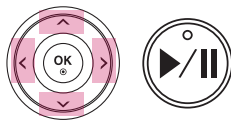

Select a file using ^ / v / < / >, and press [PLAY / PAUSE] to play the file.

· Select [Folder], and press [OK] to display contents in folder. Go to upper folder, Press [^].

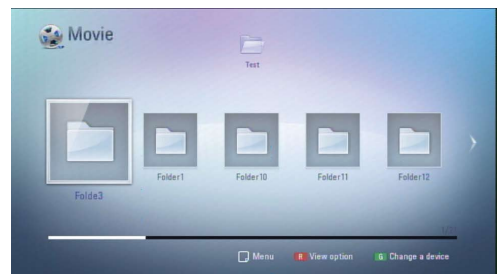

Using Colored buttons (R, G, Y, B)

Use to navigate guide menus.

They are also used for [MOVIE], [PHOTO], [MUSIC], [Home Link] and [NetCast] Menu.



Playing a Video File

❖ General Playback

General Playback



Press [PLAY / PAUSE] to play a file.



Press [STOP] to stop playing a file.
 » The unit records the point where you pressed [STOP] depending on the file. press [PLAY / PAUSE] to resume playback.
 » (from the scene point). Screen Saver : The screen saver appears when you leave the player in stop mode.

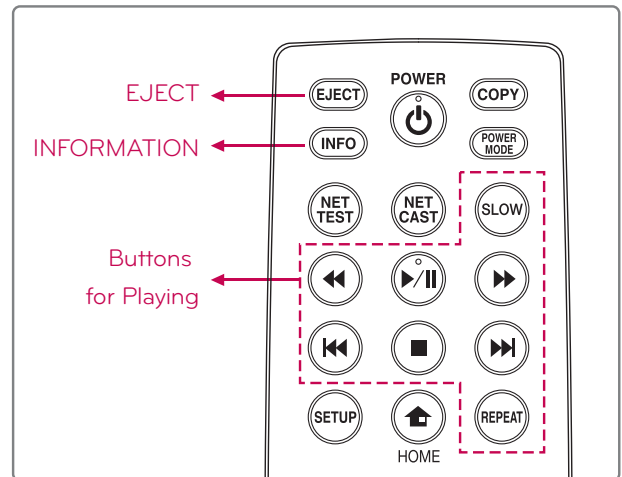

Pause



Press [PLAY / PAUSE] to pause playing a file. Press again to play a file.

Eject



Removing the USB storage device from the player without following the safe removal instruction (Eject) may cause problem to the stored data or operation of USB storage device.

- The unit records the point where you pressed [STOP] depending on the file. press [PLAY / PAUSE] to resume playback.
- The unit record 20 resume point for each USB storage drive.
- Resume function does not work properly depending on file property.

※ Change the list menu

Press [R] to change the view in [MOVIE], [MUSIC], [Photo], [Home Link] menu.

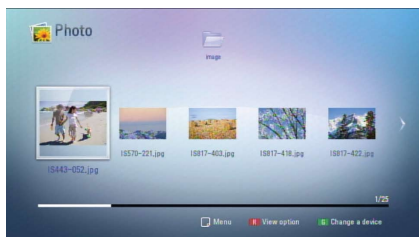

< A Type >

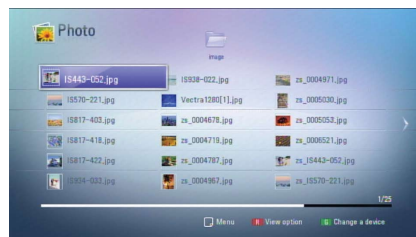

< B Type >

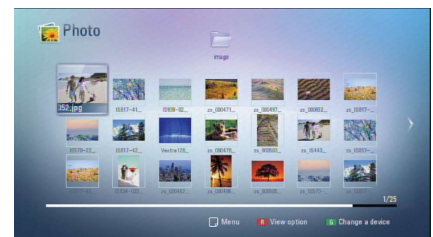

< C Type >

Playing a Video File

❖ Slow | Fast Forward / Rewind | Fast Forward / Rewind Skip (5 min)

Slow

To slow down the playing speed.

 While video file is playing, press [SLOW] repeatedly to play various speeds of slow motion.

 Press [PLAY / PAUSE] to normal speed playback.

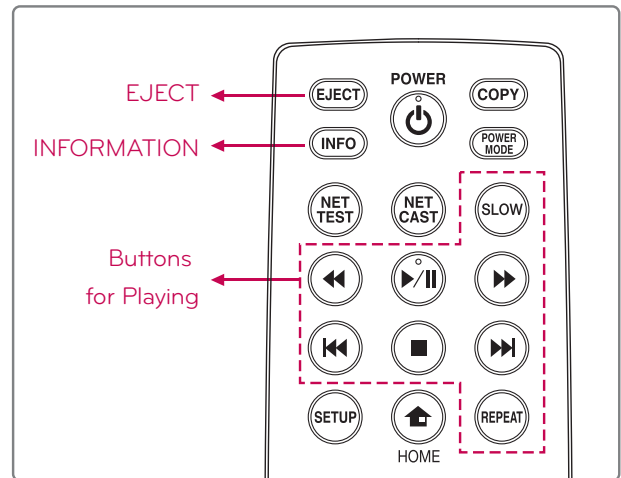

Fast Forward / Rewind

To scan Fast Forward or Rewind.

  By pressing [Fast Forward] or [Rewind], you can change the various playback speeds.

 Press [PLAY / PAUSE] to normal speed playback.

- Depending on the file properties, actual running speed may differ from displayed speed.
- Specific files including media server may not support some of Fast Forward or Rewind functions.

Fast Forward / Rewind Skip

Move to 5 minutes (Before / After)

 During playback, press [>] or [<] to go to the 5 minutes after or before.

- Specific files including media server may not support some of Fast Forward or Rewind Skip functions.
- Specific files including media server may not support some of Fast Forward or Rewind functions.

※ The movie file running time should be longer than 5 minutes to use this function.

Playing a Video File

❖ Previous / Next file playback | Repeat | Information

Previous / Next file playback

Play previous / next file.



To play previous / next file in the same folder.
(This function is not activated, if only single file is in the folder.)

Repeat Playback

Change repeat function



During playback, press REPEAT repeatedly to select a desired repeat mode.

General Playback	The current file will be played back repeatedly.	The current folder will be played back repeatedly.	General Playback.

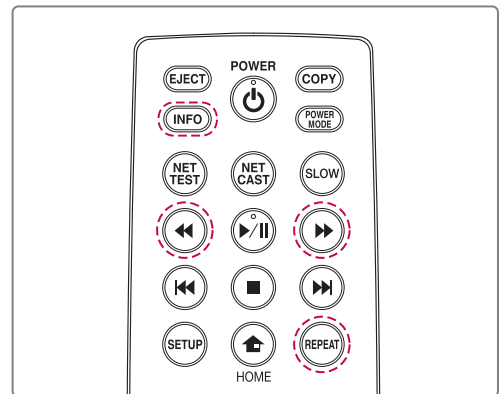

Information

The player can display the content information.

1



During playing file, press [INFO] to display the popup message. The file information appears on the screen.

2



To Close popup message, press [OK].

Playing a Video File

❖ Enlarge the Playback Video | Time Search

- Enlarge the playback video file.
- Specific files including media server may not support some of Zoom function.

Enlarge the playback video

Zoom in / out during video playing.

1



Press [ZOOM] to displays or exits the [Zoom] menu.

2



Use [R] or [G] to zoom out or in the video. To return to the normal video size, [Y].



Press [RETURN] to exit the [ZOOM] menu.



3



You can move through the zoomed video using $\wedge / \vee / \langle / \rangle$.

- If the Zoom popup menu is activated, other functions cannot be used. To use other functions, please press [RETURN] to close the Zoom popup menu.

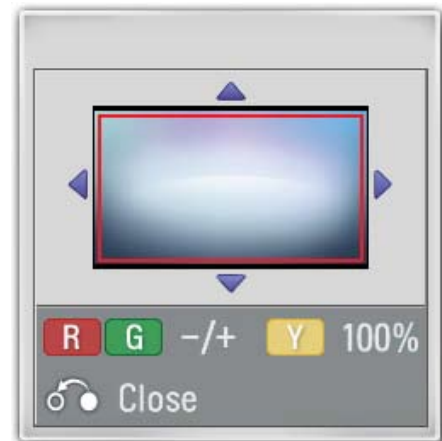
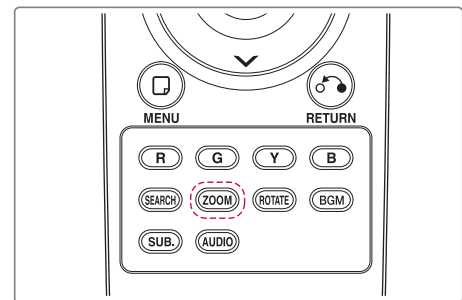

Time Search

Using time search function, you can easily find the point where you want to start playback

1

During Movie playback, press [SEARCH] to see the search time bar.

2

Press and hold \langle / \rangle to select a point what you want to play.

3

The movie will be played from the point where you want to start. (Do not need to press [OK], the movie will be played automatically.)

Playing a Video File

❖ On-Screen Display

Displaying content information on-screen

You can display and adjust various information and settings about the content.

- Available items may differ depending on contents
- If no button is pressed for a few seconds, the onscreen display disappears.

1



While playback, press [MENU] to show various playback information.

2



Use \wedge / \vee / \langle / \rangle to adjust the selected option value.

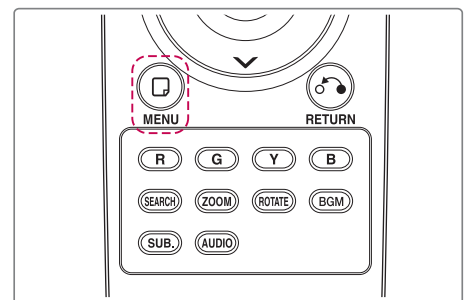

Chapter	Current chapter number/total number of chapters
Time	Elapsed playing time/total playback time
Audio	Selected audio language or channel
TV Aspect Ratio	Select a TV aspect ratio option. (4:3, 16:9)
Subtitle	Selected subtitle
Picture	Sets the Brightness / Contrast level.

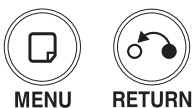

Press [MENU] or [RETURN] to exit menu or cancel the selection.

Playing a Video File

❖ Selecting Audio dubbing | Selecting Subtitle file

- If there is no subtitle  mark will be displayed.
- Subtitle may not be displayed properly, depending on TV aspect ratio or subtitle file property.

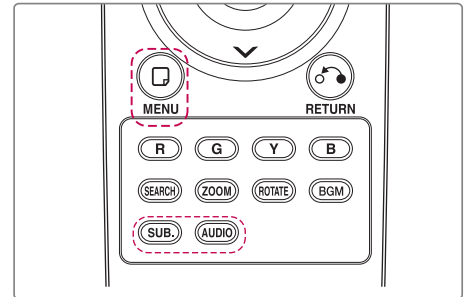

Selecting Audio dubbing

Press AUDIO to change the available audio track of movie.
If there is no dubbing audio track, it is not working.

1



During playing movie, press [MENU] and select audio option. Change the audio language you want.

2



Or During playing movie, press [AUDIO] to change the audio.

Selecting Subtitle file

Press SUBTITLE to display/hide the subtitle setting menu.

1



During playing movie, press [MENU] and select subtitle option. Change the subtitle language you want.

2



Or During playing movie, press [SUB] to change the subtitle language.

- » Text Encoding : Select to choose subtitle encoding.
- » Subtitle Size : Select to change subtitle size
- » Subtitle Position : Select to change subtitle position.
- » Subtitle Color : Select to change subtitle color.
- » Subtitle Sync : Select to change subtitle sync.

- If a video file name and the subtitle file name are the same, subtitle file is played automatically when playing the video file.

Playing a Video File

❖ Video files

Available resolution size

1920 x 1080 (W x H) pixels

Available File extentions

.dat / .mpg / .mpeg / .avi / .vob / .ts / .mov / .xvid / .mp4 / .mkv / .m2t / .m2ts /
.wmv / .asf / .iso / .m1v / .m2v / .dvr-ms (Unprotected) / .flv / .m1s / .m2p / .ifo / .tp /
.trp / .m4t / .mts

Playable Codec format

MPEG 1 / 2 / 4, DivX 3 / 4 / 5 / 6, Xvid, VC1 (WMV9), MJPEG (SD), H.264, AVC

Playable Audio format

Dolby Digital / DTS : 2 Ch (Down-mix), 5.1 Ch (Pass-through)
PCM, LPCM, ADPCM, BDLPCM, AAC, WMA, WMA Pro, MPEG-1 Layer 1 / 2 / 3
MPEG-2 Layer 1 / 2 / 3, MP3, WAV
» Bit rate : 32 ~ 320 Kbps (MP3), 20 ~ 320 Kbps (WMA)
» Sampling Frequency : 16 ~ 48 KHz (MP3), 32 ~ 48 KHz (WMA)
» Not all the WMA and AAC Audio format is compatible with this unit.

Playable subtitle

SRT, SUB, SMI, SSA, ASS, PGS, Divx Embedded subtitle, MKV Embedded
(SUB, SSA, ASS, SRT)

Note for Video files

- Specific files including media server may not be supported.
- This player does not support files that are recorded with GMC or Qpel.
(GMC – Global Motion Compensation, Qpel – Quarter pixel)
- This player supports H.264/MPEG-4 AVC profile Main, High at Level 4.1. For a file with higher level, the warning message will appear on the screen.
- OGG and FLAC (Audio codec) only support audio files. (Video files are not supported.)
- This product is not support external Blue ray Drive and DVD Drive.
- HD video files contained on the USB 1.0/1.1 may not played properly. USB 2.0 are recommended to play back HD video files.
- DRM(iTune store, Movielink, etc) is not supported.

Listening to Music File

❖ General Playback

General Playback

The player can play various audio files.

To see the file information (Audio codec, Audio codec, Album title, Musician), press [INFO] after selecting the file.

1

Connect USB Drive or External Hard Disk Drive to Multimedia Player.

2



Press [HOME], Select [Music] using < / >, and Press [OK].



3



Select [USB1] or [USB2] option using < / >, and press [OK].

Select [Folder], and press [OK] to display contents in folder. Go to upper folder, Press [Return].

4

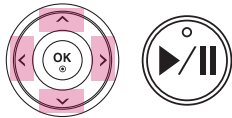

Select a file using ^ / v / < / >, and press [PLAY / PAUSE] to play the file.

※ Change the list menu

Press [R] to change the view in [MOVIE], [MUSIC], [Photo], [Home Link] menu.

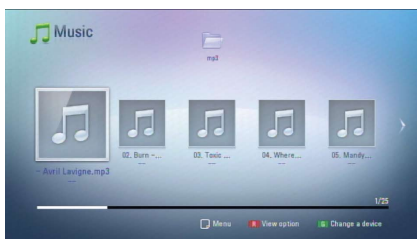

< A Type >

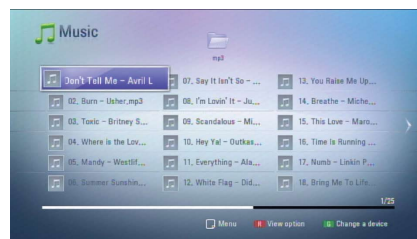

< B Type >

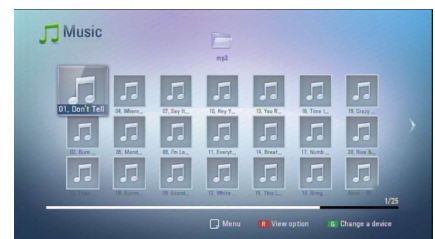

< C Type >

Listening to Music File

❖ General Playback | Fast Forward / Rewind | Repeat Playback



Press [PLAY / PAUSE] to play a file.



Press [STOP] to stop playing a file.

Pause



Press [PLAY / PAUSE] to pause playing a file.
Press again to play a file.

Eject



Removing the USB storage device from the player without following the safe removal instruction (Eject) may cause problem to the stored data or operation of USB storage device.

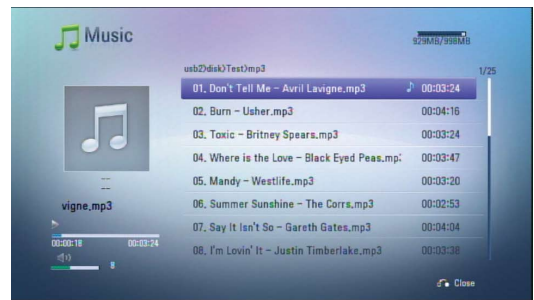
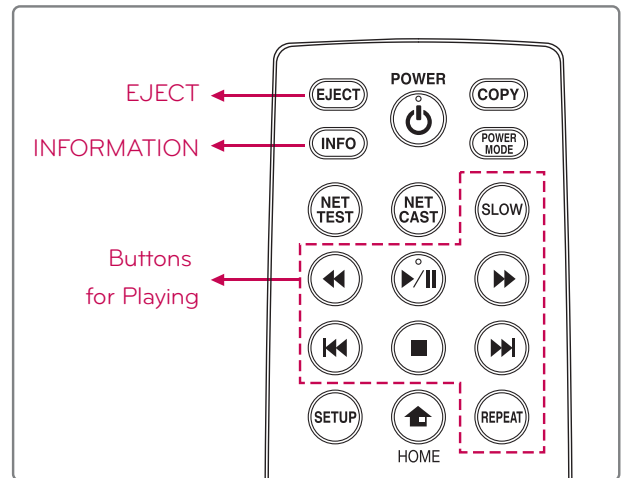

Fast Forward / Rewind

To scan Fast Forward or Rewind.



By pressing [Fast Forward] or [Rewind], you can change the various playback speeds.

- This unit can support the ID3 Tag embedded MP3 file.
 - : Album image, Musician, etc.
- MP3 files with ID3 Tag including album image display the album image instead of note.

Repeat playback

Change repeat function



During playback, press REPEAT repeatedly to select a desired repeat mode.

- | | |
|--|---|
| | General Playback |
| | The current track or file will be played back repeatedly. |
| | The current folder will be played back repeatedly. |
| | All the tracks or files will be played back repeatedly in random order. |
| | The tracks or files will be played back in random order. |

Listening to Music File

❖ Previous / Next file playback | Information

Previous / Next file playback

Play previous / next file.



To play previous / next file in the same folder.
(This function is not activated, if only single file is in the folder.)

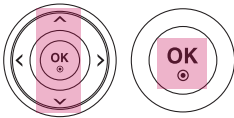

Select a file using \wedge / \vee , and press [OK] to play another music file.

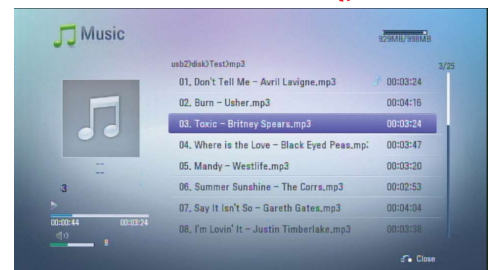
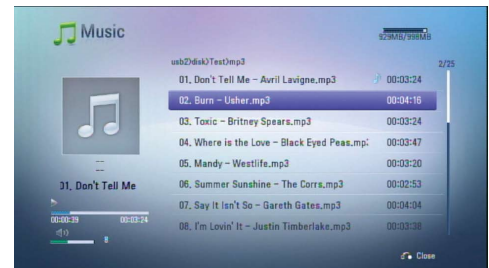

Information

The player can display the content information.

1



During playing file, press [INFO] to display the popup message. The file information appears on the screen.

2



To Close popup message, press [OK].

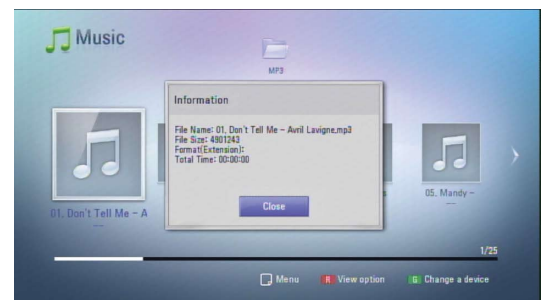

Viewing a Photo File

❖ General Playback

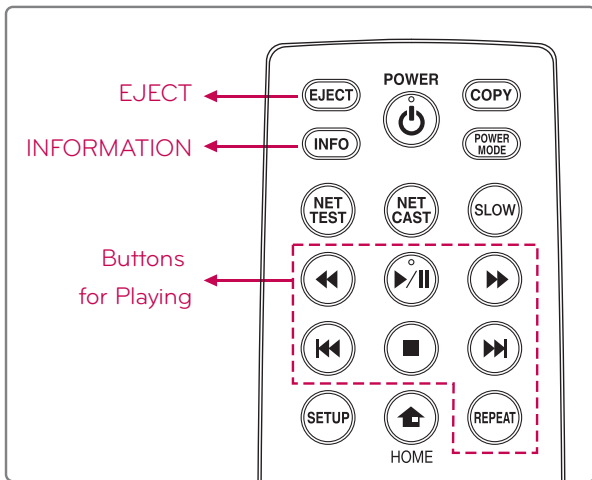

File compatibility

- Available file extension : .gif .bmp .jpg .jpeg .png .tif .tiff
- Depending on the size and number of the files, it may take several minutes to read the USB storage drive.
- In [Photo] menu, the photo file with [?] image is not supported.
- Recommended size :
 - BMP/TIFF/PNG/GIF : Less than 2048 x 2048 pixel
 - JPG : Less than 4,096 X 4,096 X 24 bit / pixel
- Animation GIF is not supported.

General Playback

1

Connect USB Drive or External Hard Disk Drive to Multimedia Player.

2

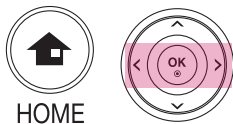

HOME

Press [HOME], Select [Photo] using < / >, and Press [OK].

3



Select [USB 1] or [USB 2] option using < / >, and press [OK].

4



Select a file using ^ / v / < / >, and press [PLAY / PAUSE] to play the file.



- Select [Folder], and press [OK] to display contents in folder. Go to upper folder, Press [Return].

※ Operation of buttons



Start / pause a slide show.



Moves to the next or previous photo.

Viewing a Photo File

❖ Repeat Playback | Enlarge the Playback Image

Repeat playback

Change repeat function.



During playback, press REPEAT repeatedly to select a desired repeat mode.

General Playback	The current folder will be played back repeatedly.	All the tracks or files will be played back repeatedly in random order.	The tracks or files will be played back in random order.	General Playback

Enlarge the playback image

Zoom in / out during photo viewing.

1



Press [ZOOM] to displays or exits the [Zoom] menu.

2



Use [R] or [G] to zoom out or in the image. To return to the normal image size, [Y].



Press [RETURN] to exit the [ZOOM] menu.



3

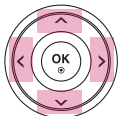

You can move through the zoomed image using $\wedge / \vee / \langle / \rangle$.

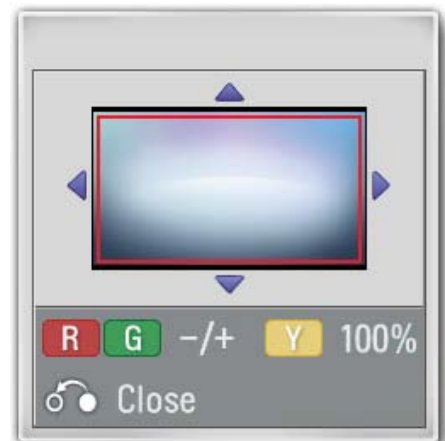
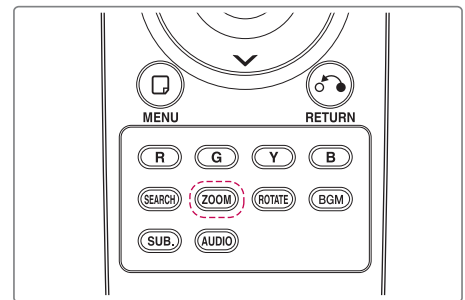

· If the Zoom popup menu is activated, other functions cannot be used. To use other functions, please press [RETURN] to close the Zoom popup menu.

Viewing a Photo File

❖ On-Screen Display

1



Select a photo file you want to view and press [OK] to see the photo in full screen.

2



While viewing a photo in full screen, press [MENU] to display the option menu.

3



Select an option using \wedge / \vee and press [OK] to change options.

※ Option Menu

- Slide Show : Press [OK] to start or pause slide show.
- Music Select : Select the background music for the slideshow.
(All of music files in the same folder will be played.)
Press [BGM] button on the remote control for same function.
Press [REPEAT] button on the remote control to change the repeat playback.
- Music Start : Press [OK] to start or pause background music.
To start Background music, choose [Music Selection] first..
- Rotate : Press $<$ / $>$ to rotate the photo anticlockwise / clockwise
(or Press [ROTATE] to rotate the photo clockwise.)
- Zoom/Pan : Press [OK] to display the [Zoom] menu.
- Effect : select a transition effect between photos in a slide show.
- scaling : Press $<$ / $>$ to change scaling mode.
(Fit to Screen, Stretch to Screen and Original Size)
- Speed : select a delaying speed between photos in a slide show.

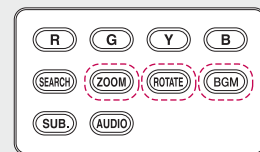

Playing YouTube Videos

❖ About YouTube Menu

You can use YouTube service (Video) via internet with NetCast Entertainment Access feature. You can browse, search and watch YouTube videos over the internet to your TV via LG Multimedia Player.

The content of YouTube services and service related information, including user interface, is subject to changes. Please refer to the web site of each service for most-up-date information.

Using YouTube features with wireless network connection may result in improper streaming speed by interference from household devices that are using radio frequencies.

About YouTube Menu

1

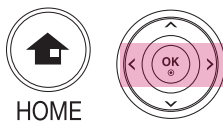

In [HOME] Menu, select [NetCast] Menu, and press [OK].

2



In [NetCast] Menu, select [YouTube], and press [OK].

3



Select the content you want to play, and press [OK].

- **Featured** : The featured videos list will be displayed.
- **Recent Videos** : The most recently updated videos list will be displayed.
- **Most Viewed** : The most viewed videos list will be displayed.
The period option appears at the bottom of the screen.
- **Top Rated** : The best rated videos list from YouTube server will be displayed. The period option appears at the bottom of the screen.
- **My video** : Display my video.
- **Favorites** : This option will be appeared only when the unit is in sign-in status. Display the videos list that is arranged in the YouTube server with your account. Some videos may not appear on the [Favorites] list, even if the videos are arranged in the server.
- **Playlists** : Display playlists.
- **Search** : The virtual keyboard will be displayed. See "Searching videos" Chapter.
- **Sign in (Sign out)** : Displays the virtual keyboard to sign in or returns to the sign-out status. See "Sign in / Sign out" Chapter.
- **Local** : Choose which country's videos you would like to view. The countries listed on the [Local Site] menu may differ with those listed on the YouTube web site.

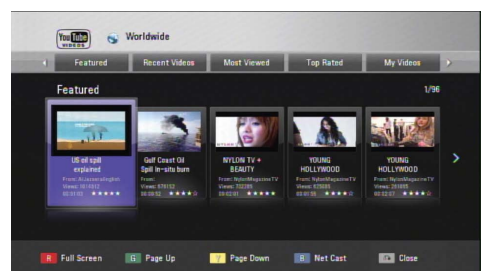
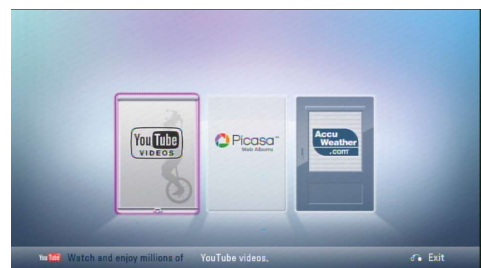
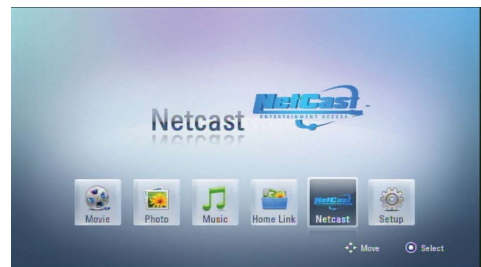

- If you select the [Most Viewed] or [Top Rated] option in the YouTube menu, the period options appear at the bottom of the screen. Use </> / ^ / v to select a period option and press [OK] to display the videos list within the selected period.
- The YouTube menu can display 5 videos in the videos list. Press [PAGE] to display previous / next 5 videos.
- The video list searched from the player may differ with the list searched from a web browser on PC.

Playing YouTube Videos

❖ Playing YouTube Videos

Playing YouTube Videos

1



In [YouTube] menu, use < / > to select a video and press [OK] or [PLAY / PAUSE]. The Content will be played.
» Video will be played automatically.
(It takes some time to play video)

※ Operation of Buttons



Start playback the video. Press again to pause current playback. To resume playing a paused video. Press again.



Skip the playback forward / backward. (10 seconds)



Toggle between playback in full screen and playback screen with content detail.



Stop the video and displays related videos list.



RETURN

Stop the video and go to previous menu.

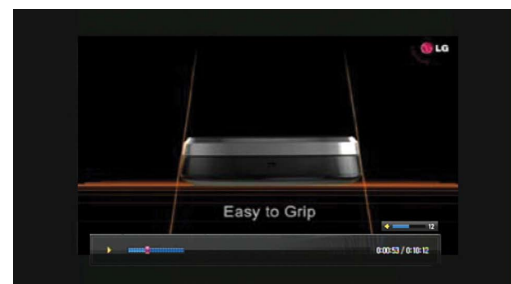
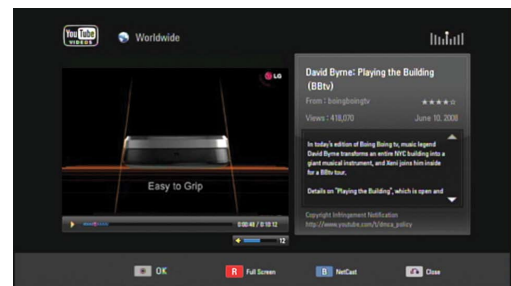
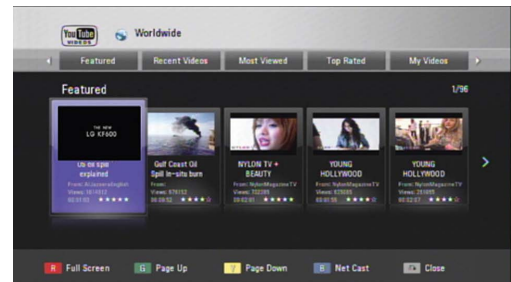

Even if you use a high-resolution setup, audio / video quality may be compromised based on the speed of your broadband internet connection. Your Internet Service Provider (ISP) determines your broadband speed. We recommend a minimum connection speed of 1.5 Mbps. For the best quality picture, a connection speed of 4.0 Mbps is required. Sometimes your broadband speed varies based on your ISP's network conditions. Contact your ISP if you have problems maintaining a fast connection that is reliable, or if you want to increase your connection speed. Many ISPs offer a variety of broadband speed options.

Playing YouTube Videos

❖ Sign in / Sign out

Sign in / Sign out

To Watch videos from your [Favorites] video list on the YouTube server with your account, you need to sign in with your YouTube account.

1



Use </> to select [Sign In] option from the menu and press [OK] to display the virtual keyboard.

2



Use </> / ^ / v to select a character then press [OK] to confirm your selection on the virtual keyboard.

» Refer to previous page for using virtual keyboard.

3



When you finish entering the user name and the password, select [OK] and press [OK] to sign in.

» Some of menus will be selected after sign in.

4



If you want to sign out, select the [Sign Out] from the YouTube menu and press [OK].

» Some of menus will not be selected after sign out.

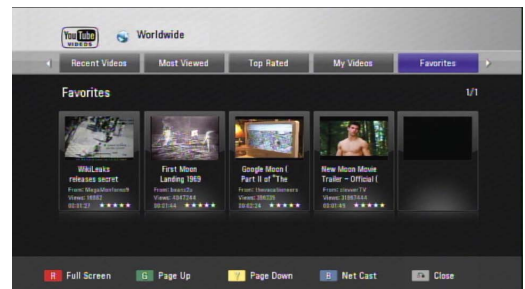
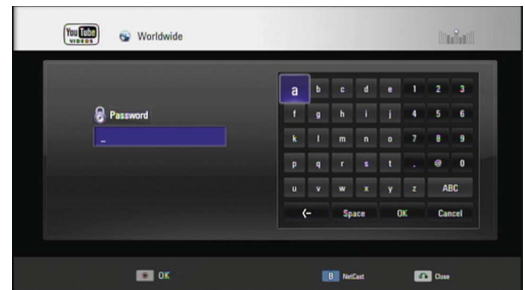
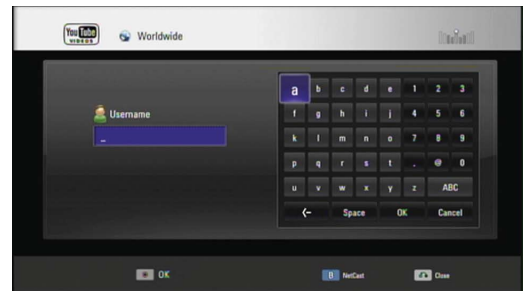
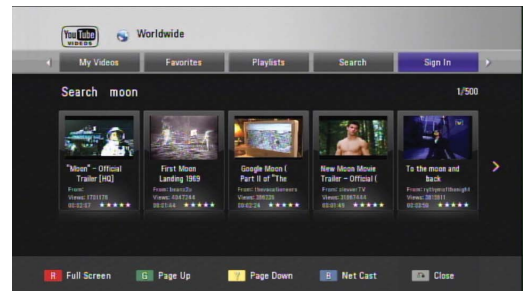

Playing YouTube Videos

❖ Searching Videos

Searching Videos

1

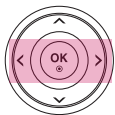

In [YouTube] menu, select [Search], and press [OK] to display the virtual keyboard.

2



Finish entering the search words.

- Backspace : Deletes the previous character at the cursor position.
- Space : Inserts a space at the cursor position.
- OK : Search YouTube video.
- abc : Changes the virtual keyboard setting to small letters.
- ABC : Changes the virtual keyboard setting to capital letters.
- #+ -= & : Changes the virtual keyboard setting to symbols

3



Select [OK] and press [OK] to display the related video list.

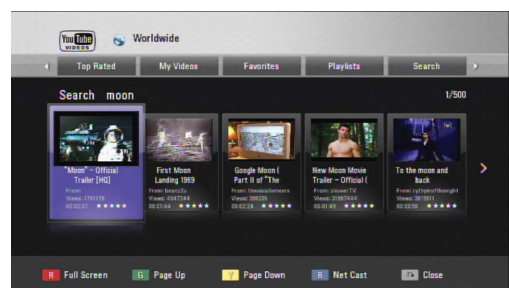
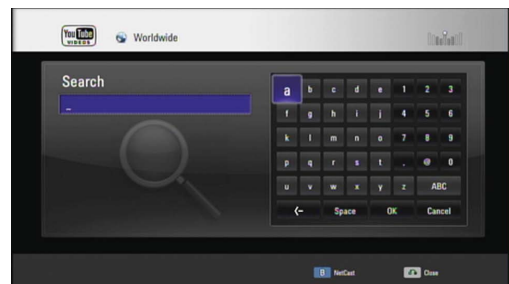

Viewing Picasa Web Albums

❖ About Picasa Web Albums Menu

You can use Picasa Web Albums service (Photo) via internet with NetCast Entertainment Access feature.

Enjoy photo albums from friends and family on the Picasa on-line service.

The content of Picasa Web Albums services and service related information, including user interface, is subject to changes. Please refer to the web site of each service for most-up-date information.

Using Picasa Web Albums features with wireless network connection may result in improper streaming speed by interference from household devices that are using radio frequencies.

About Picasa Web Albums Menu

1



HOME



In [HOME] Menu, select [NetCast] Menu, and press [OK].

2



In [NetCast] Menu, select [Picasa Web Albums], and press [OK].

3



Select the content you want to play, and press [OK].

- Home : The featured photo list will be displayed.
- NetCast Friends : List of your friends will be displayed.
- Search : Enter a search word to find related photos. The virtual keyboard will be displayed.
- My Photos : Displays the photos organized in my Picasa Web Album. This option is available only when the unit is in sign-in status.
- Favorites : Displays favorite web albums that are arranged in the Picasa web server with your account. This option is available only when the unit is in sign-in status.
- Sign in (Sign Out) : Displays the virtual keyboard to sign in or returns to the sign-out status



- When a photo is selected, press [G] or [Y] to display [Previous] or [Next] page
- Photos displayed in [My Photos] and [Favorites] may differ with the photos from a web browser on PC.

Viewing Picasa Web Albums

❖ Viewing Picasa Web Albums

Viewing Picasa Web Albums

1



On the player, selected the [Picasa Web Albums] option in the [NetCast] Menu using < / >, and press [OK].

» Featured photos are appeared on the screen.

※ Operation of buttons



Start / pause a slide show.



Moves to the next or previous photo.

1



While viewing a photo in full screen, press [Menu] to display the option menu.



※ Option Menu

- Slide show : Press [OK] to start or pause slide show.
- Add to NetCast friends list : Add the current photo owner to my friend list.
- Rotate : Press [OK] to rotate the photo (Clockwise / Anti-clockwise) or press [Rotate] button on the remote control.
- Zoom : Press [OK] to display the [Zoom] menu or press [Zoom] button on the remote control.
- Effect : Select a transition effect between photos in a slide show.
- Speed : Select a delaying speed between photos in a slide show.

· Photos displayed in [My Photos] and [Favorites] may differ with the photos from a web browser on PC.

Viewing Picasa Web Albums

❖ Sign in / Sign out

Sign in / Sign out

To display photos in your web album on the screen, you need to sign in with your Picasa account.

1



Use </> to select [Sign In] option from the menu and press [OK] to display the virtual keyboard.

2



Use </>/^/∨ to select a character then press [OK] to confirm your selection on the virtual keyboard.

3



Enter the password using the virtual key board, and press [OK] while [OK] is selected.
» Some of menus will be selected after sign in.

4



If you want to sign out, select the [Sign Out] from Picasa menu and press [OK].
» Popup message will be shown for confirmation. Select [YES] and press [OK].
» Some of menus will not be selected after sign out.

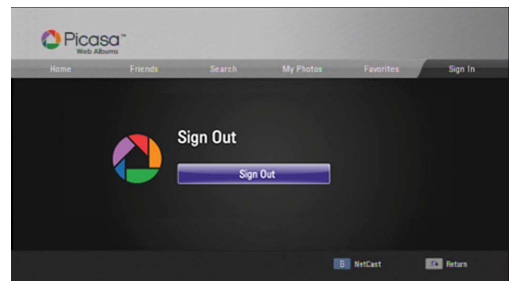
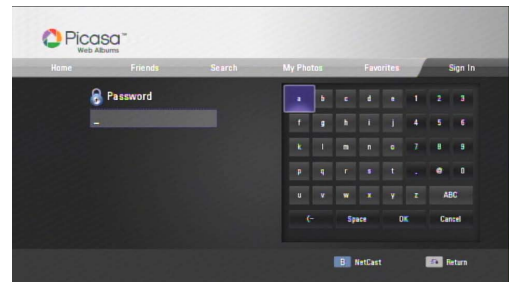
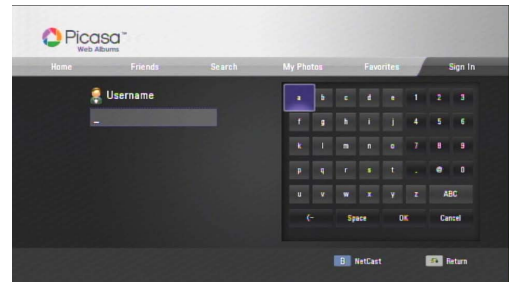

Viewing Picasa Web Albums

❖ Searching Photos

Searching Photos

1



In [Picasa Web Albums] menu, select [Search], and press [OK] to display the virtual keyboard.

2



Finish entering the search words.

- Backspace : Deletes the previous character at the cursor position.
- Space : Inserts a space at the cursor position.
- OK : Search YouTube video.
- abc : Changes the virtual keyboard setting to small letters.
- ABC : Changes the virtual keyboard setting to capital letters.
- #+--& : Changes the virtual keyboard setting to symbols.

3



Select [OK] and press [OK] to display the related video list.

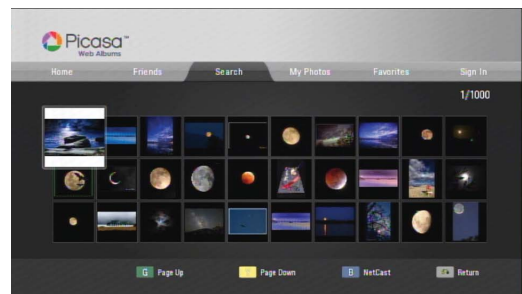
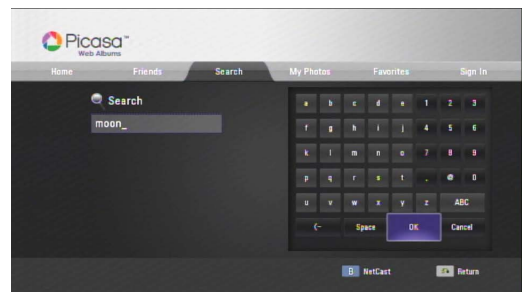
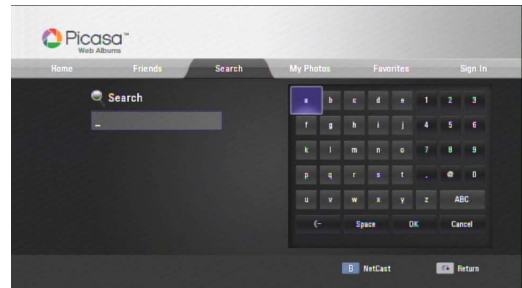

Viewing Picasa Web Albums

❖ Adding NetCast friends

Adding NetCast friends

If you add your friends on the [NetCast Friends] menu, you can see the photos of your friend's public photos directly.

1



Select the [NetCast Friends] on the Picasa menu using </>/^/</>/^/∇, and press [OK].

2



If there is no NetCast friend, select [Add to NetCast Friends List], and press [OK].
» The virtual keyboard will be displayed.

3



Enter a name / ID using the virtual keyboard and select [OK], and press [OK] to see the photo what your friends uploaded.

- To display the [NetCast Friends] List, press [Y]
- If you want to delete your friend from the list, select [X] and press [OK].

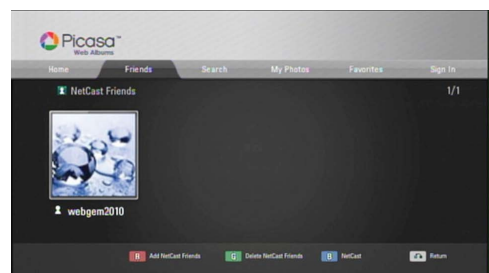
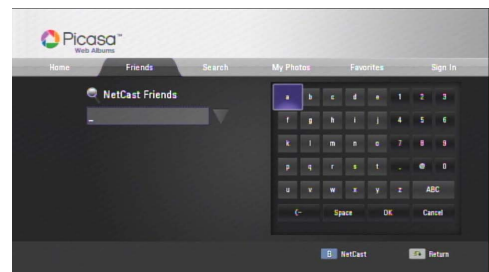
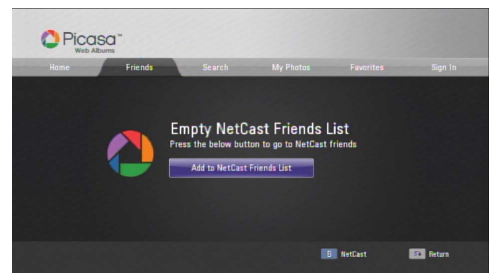

Using the AccuWeather

You can use AccuWeather service (Weather) via internet with NetCast Entertainment Access feature.

See on-line local and global weather forecasts from AccuWeather.com.

The content of AccuWeather services and service related information, including user interface, is subject to changes. Please refer to the web site of each service for most-up-date information.

Using AccuWeather features with wireless network connection may result in improper streaming speed by interference from household devices that are using radio frequencies.

1



HOME



In [HOME] Menu, select [NetCast] Menu, and press [OK].

2



In [NetCast] Menu, select [AccuWeather], and press [OK].
» The city selection menu appears on the screen.

3



In [Favorite City List], select region, country and city and press [OK].
Select the [X] symbol and press [OK] to delete the stored favorite city.

4

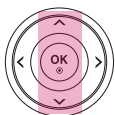

Select a city from the [Favorite City List], and press [OK] to display the weather information.

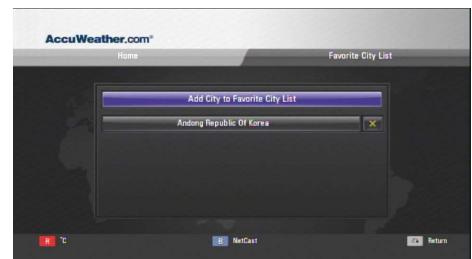
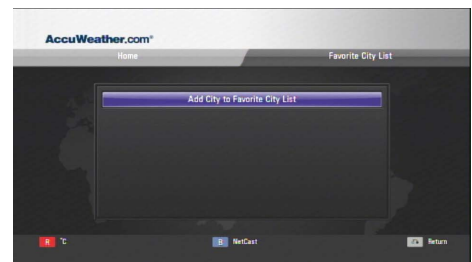

Playing content via your home network

❖ Accessing a DLNA media server

The player can browse and play content on your PC and DLNA certified media servers connected on your home network.

About DLNA

This Player is a DLNA Certified digital media player that can display and play movie, photo and music content from your DLNA compatible digital media server (PC and Consumer Electronics).

The Digital Living Network Alliance (DLNA) is a cross-industry organization of consumer electronics, computing industry and mobile device companies. Digital Living provides consumers with easy sharing of digital media through a wired or wireless network in the home.

When a PC running DLNA server software or other DLNA compatible device is connected to this player, some setting changes of software or other devices may be required. Please refer to the operating instructions for the software or device for more information.

1

Start your PC that connected on your local area network. On your PC, share folders which contain movie, photo or audio files.

» The player and PC should be connected to same router (AP and Gateway).



2



In [HOME] menu, select [Home Link] using < / >, and press [OK].

» Check the network connection and settings. (SAMBA Server or UPnP Server)

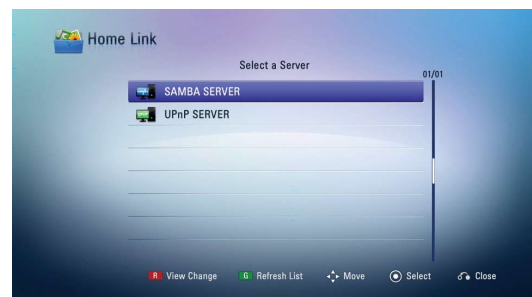

Depending on the media server, this player may need to get permission from the server.

The playback and operating quality of the [Home Link] function may be affected by your home network condition. Playing content via your home network

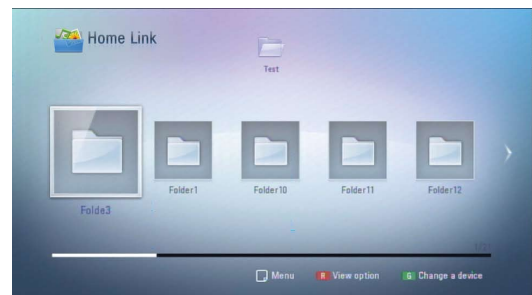

※ Caution

To connect to UPnP Server, current connected AP's UPnP port should be enable.
To connect to UPnP Server, Windows Media Player 11.0 or later version is required.

Playing content via your home network

❖ Accessing a DLNA media server

3



Select a DLNA media server from the list using < / >, and press [OK].

- » Depending on the media server, this player may need to get permission from the server. If there is no network user ID and password, just select [OK] and press [OK].
- » Depending on the share folder, this player may need to input network user ID and password for accessing the folder.
- » If you want to rescan available share folders, press [G].

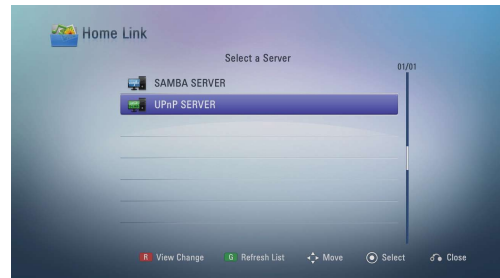

<Example of DLNA server selection>

4



Select a file, and press [OK] to play the file.

- » Shared folders / files are shown in the list.
- » To play the file please see [Playing a video file], [Viewing a photo] and [Listening to music] chapter.

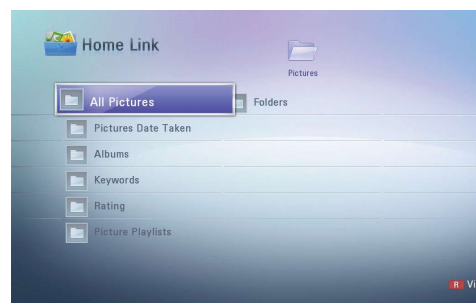
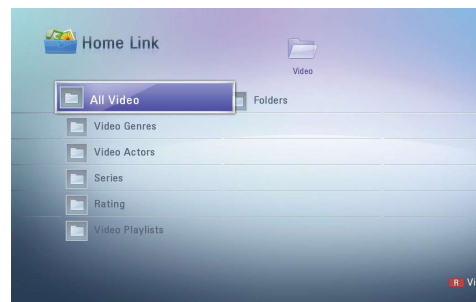
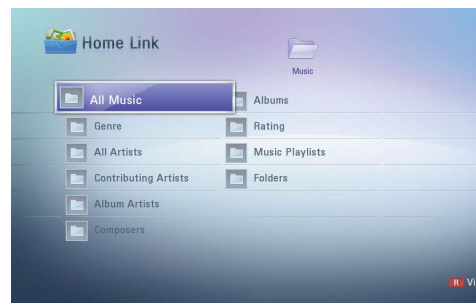
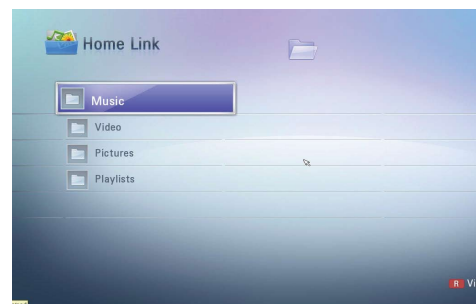

- The UPnP selection screen can differ according to server. (UPnP is controlled by the server.)

Playing content via your home network

❖ Entering a network user ID and the password | Sharing files and folders

Entering a network user ID and the password

Depending on your PC's environment, you may need to enter a network user ID and the password for accessing a shared folder.

1



In [HOME] menu, select [Home Link] and press [OK].
» Server selection menu will be displayed.

2

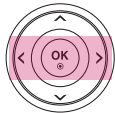

The keyboard menu appears automatically if the network user ID and the password are required.

3



The network user ID and password will be remembered after accessing the folder for your convenience.

4



When you finish entering the network user ID and password, select [OK] and press [OK] to access the folder..

Sharing files and folders

You may experience connection problems depending on your PC's environment.

PC requirements

Windows® XP (Service Pack 2 or higher),

Windows Vista® (no Service Pack required)

Windows 7® (no Service Pack required)

1.2 GHz Intel® Pentium® III or AMD

Sempron™ 2200+ processors

Network environment: 100 Mb Ethernet,

WLAN (IEEE 802.11 b/g/n)

If you use Windows® XP or Windows Vista®, visit link below for more information on file share settings.

Windows XP : <http://support.microsoft.com/kb/304040>

Windows Vista : <http://support.microsoft.com/kb/961498>

· To share the folder using UPnP Server, Windows Media Player 11.0 or later version is required.

Playing content via your home network

❖ File Compatibility

Overall

※ Available file extensions

.dat / .mpg / .mpeg / .avi / .vob / .ts / .mov / .xvid / .mp4 / .mkv / .m2t / .m2ts / .wmv / .asf / .iso / .m1v / .m2v / .dvr-ms(Unprotected) / .flv / .m1s / .m2p / .ifo / .tp / .trp / .m4t / .mts / .wma / .mp3 / .ogg / .flac / .gif / .bmp / .jpg / .jpeg / .png / .tif / .tiff

» Available file extensions differ depending on the DLNA servers.

※ Available resolution size

1920 x 1080 (W x H) pixels

※ Playable video codec format

MPEG 1 / 2 / 4, DivX 3 / 4 / 5 / 6, Xvid, VC1 (WMV9), MJPEG (SD), H.264, AVC

※ Playable audio codec format

Dolby Digital / DTS : 2 Ch (Down-mix), 5.1 Ch (Pass-through)
PCM, LPCM, ADPCM, BD LPCM, AAC, WMA, WMA Pro, MPEG-1 Layer 1 / 2 / 3
MPEG-2 Layer 1 / 2 / 3, MP3, WAV
Bit rate : 32 ~ 320 Kbps (MP3), 20 ~ 320 Kbps (WMA)
Sampling frequency : 16 ~ 48 KHz (MP3), 32 ~ 48 KHz (WMA)
Not all the WMA, AAC Audio format is compatible with this unit.

※ Playable Subtitle

SRT, SUB, SMI, SSA, ASS, vobsub, PGS

※ Audio Codec

WAV, AC3, AAC, WMA, WMAPro, MP3, FLAC
OGG (Sample rate 32 K (Q0) ~ 192 K (Q6),

※ Recommended Photo size

Less than 4,096 X 4,096 X 24bit/pixel

- Available file extensions differ depending on the DLNA servers.
- The overall files are not always compatible. There may have some restrictions by file features and media server's ability.. This function may not work on some [Home Link] content depending on the file type and ability of the DLNA server.
- The thumbnail of the unplayable files can be displayed in the [My Media] menu, but those cannot be played on this player.
- The subtitle file name and video file name have to be the same and located at the same folder.
- Some of functions are not available for NetCast on-line content and content in DLNA servers.
- Some of functions may not work on some [Home Link] content depending on the file type and ability of the DLNA server.
- The files from removable media such as USB Storage Drive on your media server may not be shared properly.

Trouble Shooting

❖ General

Symptom	Cause & Solution
The Power does not turned on.	Plug the power cord into the wall outlet securely.
Cannot play movie, photo or audio files.	The files are not recorded in a format that the unit can play. The unit does not support the codec of the video file.
The remote control does not work properly.	The remote control is not pointed at the remote sensor of the unit. The remote control is too far from the unit. There is an obstacle in the path of the remote control and the unit. The batteries in the remote control are exhausted.
The unit is plugged in, but the power will not turn on or off.	You can reset the unit as follows. 1. Press and hold the [POWER] for at least five seconds. This will force the unit to power off then turn the unit back on. 2. Unplug the power cord, wait at least five seconds, and then plug it in again.
The unit is not operating normally.	» Press [Reset] button on the rear of the player to reset.

Trouble Shooting

❖ Picture

Symptom	Cause & Solution
There is no picture.	Select the appropriate video input mode on the TV so the picture from the unit appears on the TV screen. Connect the video connection securely. Check the [HDMI Color Setting] in the [Setup] menu is set to the appropriate item that conforms to your video connection. Your TV may not support the resolution you have set on the player. Change the resolution that your TV accepts. The player's HDMI OUT jack is connected to a DVI device that does not support copyright protection.
Picture noise appears	You are playing a disc recorded in a color system that is different from your TV. Set the resolution which your TV accepts..
During playing movie, "Bitstream error" message is shown.	In case of display "Bitstream Error" during playing, please press FF to skip the error section of abnormal file before message comes up again. The movie may or may not play depending on the error severity of file. (It may not work depending on the file.)

❖ Sound

Symptom	Cause & Solution
There is no sound or the sound is distorted.	Connect the audio connection securely. The input source setting on the amplifier or the connection to the amplifier is incorrect. The unit is in scan, slow motion, or pause mode. The sound volume is low. Check that the connected amplifier is compatible with audio format output from the player. The player's HDMI OUT jack is connected to a DVI device. The DVI jack does not accept audio signal. Check the device connected to player's HDMI OUT jack is compatible with audio format output from the player.

❖ Network

Symptom	Cause & Solution
Streaming video services (such as YouTube™, etc.) are often stopped or “buffer” during playback.	Your broadband service speed may not be fast enough to stream video services. Contact your Internet Service Provider (ISP) and increase the broadband speed is recommended.
Shared folder or files from your PC or a media server are not displayed on the [Home Link] menu.	The firewall or anti-virus software on your media server is running. Turn off the firewall or anti-virus software running on your PC or media server. The player is not connected to the local area network that your PC or the media server are connected.
Cannot connect the player to the access point or wireless LAN router.	The wireless communication may be interrupted from household devices that are using radio frequencies. Move the player away from them.
Access point is not displayed on the “Access point name” list.	The access point or wireless LAN router may not broadcast its SSID. Set your access point to broadcast its SSID through your computer.

※ Customer Support

You can update the Player using the latest software to enhance the products operation and/or add new features. To obtain the latest software for this player (if updates have been made), please visit <http://www.lgservice.com>

※ WPS PBC Mode

WPS : Wi-Fi Protect Setup

PBC : Push Button Connect

- Press PBC button on the Access Point / Wireless router to connect to player directly.
(Some of Access Point / Wireless routers do not have the PCB button.)
- First of all, proper wireless network setting is required.
- In the Wireless Network list, Press “Push Button” and the press PCB button on the Access Point / Wireless router, it will be directly connected in 2 minutes

※ If the product is not working properly, press [Reset] button on the rear of the product to restore factory default.

❖ Network Connection

1. How does you manually connect to the network?

- Please refer to the connection setting directions under network options in the user's manual.
- Automatic connection is the recommended setting.

2. Network failed to connect.

- 1) Check to see if the network (wired or wireless) is connected.
- 2) Check to see if the local network is connected.
- 3) Network access can be restricted or limited, please check your security options and allow access.
- 4) In addition, there could be a problem with your AP router.
- 5) If problem persists, please contact your network service providers.

3. What are the compatible Wi-Fi speeds?

- 802.11 b / g is available in Russia.
- 802.11 b / g / n is available in all others areas.

❖ Home Link Guide

1. My PC is connected to a compatible router(wired or wireless), but the DP1 is not responding.

- 1) Check to see that the Multimedia player and PC are connected to the same network.
- 2) Check to see that the router is functioning correctly.
- 3) To refresh the network, press [G] button in the remote control.
- 4) Check to see if firewalls are on.

2. Which OS are supported?

- Windows 7, Windows Vista, Windows XP, MAC and Linux compatible.

3. Where must the PC files be placed to be seen on DP1?

Is there a designated location?

- There is no designated location but the files and folders must be accessible and shared on network.
- It is recommend that files be kept as close to the directory as possible instead of being placed within many folders.

4. When connecting to a PC through Home link, is an ID/PW required?

- You should use the ID/PW from your account.
- Depending on user settings, a password may not be required to connect to a network. If a password is not required, press [OK] button without entering any characters.

5. Home link cannot connect.

- ID/PW was not entered correctly.
- Firewall settings may be turned on.

6. Home link appears connected when using a cable but does not connect through Wi-Fi.

- When using AP in both cable and Wi-Fi connections, be sure the Gateway information is correct. If Home link and PC are not using the same Gateway, then the PC may not appear on Home link. If possible, it is recommended that both the PC and DP1 are connected by cable.

IMPORTANT INFORMATION RELATING TO NETWORK SERVICES

❖ IMPORTANT INFORMATION RELATING TO NETWORK SERVICES

PLEASE READ CAREFULLY. USE OF THE NETWORK SERVICES IS SUBJECT TO THE FOLLOWING TERMS AND CONDITIONS.

Use of the Network Services requires an Internet connection which is sold separately and for which you are solely responsible. The Network Services may be limited or restricted depending upon the quality, capabilities and technical limitations of your Internet service.

The Network Services belong to third parties and may be protected by copyright, patent, trademark and/or other intellectual property laws. The Network Services are provided solely for your personal and noncommercial use. Unless expressly authorized by the respective content owner or service provider, you shall not modify, copy, republish, upload, post, transmit, translate, sell, create derivative works, exploit, or distribute in any manner or medium any content or services accessible through this product.

LG IS NOT RESPONSIBLE FOR YOUR USE OF THE NETWORK SERVICES. THE NETWORK SERVICES ARE PROVIDED "AS IS." TO THE FULLEST EXTENT PERMISSIBLE BY LAW, LG MAKES NO REPRESENTATIONS OR WARRANTIES OF ANY KIND WHATSOEVER (i) FOR THE ACCURACY, VALIDITY, TIMELINESS, LEGALITY, OR COMPLETENESS OF ANY NETWORK SERVICE MADE AVAILABLE THROUGH THIS PRODUCT; OR (ii) THAT THE NETWORK SERVICES ARE FREE OF VIRUSES OR OTHER COMPONENTS THAT MAY INFECT, HARM, OR CAUSE DAMAGE TO THIS PRODUCT, YOUR COMPUTER, TELEVISION, OTHER EQUIPMENT, OR ANY OTHER PROPERTY. LG EXPRESSLY DISCLAIMS ANY IMPLIED WARRANTIES, INCLUDING BUT NOT LIMITED TO, WARRANTIES OF MERCHANTABILITY OR FITNESS FOR A PARTICULAR PURPOSE.

UNDER NO CIRCUMSTANCES AND UNDER NO LEGAL THEORY, WHETHER IN CONTRACT, TORT, STRICT LIABILITY OR OTHERWISE, SHALL LG BE LIABLE TO YOU OR ANY THIRD PARTY FOR ANY DIRECT, INDIRECT, INCIDENTAL, SPECIAL, STATUTORY, CONSEQUENTIAL OR OTHER DAMAGES OR ATTORNEY FEES OR EXPENSES RELATING TO OR ARISING OUT OF THE NETWORK SERVICES EVEN IF ADVISED OF THE POSSIBILITY OF SUCH DAMAGES OR IF SUCH DAMAGES COULD HAVE BEEN REASONABLY FORESEEN.

The Network Services may be terminated or interrupted at any time, and LG makes no representation or warranty that any Network Service will remain available for any period of time. Use of the Network Services may be subject to additional terms and conditions of the respective third party service provider. The Network Services are transmitted by third parties by means of networks and transmission facilities over which LG has no control. LG EXPRESSLY DISCLAIMS ANY RESPONSIBILITY OR LIABILITY FOR ANY INTERRUPTION OR SUSPENSION OF ANY NETWORK SERVICE.

LG shall be neither responsible nor liable for customer service related to the Network Services. Any question or request should be made directly to the respective Network Service providers.

"Network Service(s)" means the third party services accessible through this product including but not limited to all data, software, links, messages, video and other content found thereon or used in connection therewith.

"LG" means LG Electronics, Inc. its parent company and all of their respective subsidiaries, affiliates and related companies worldwide.

Trademarks and Licenses



Manufactured under license from Dolby Laboratories.
Dolby and the double-D symbol are trademarks of Dolby Laboratories.



Manufactured under license under U.S. Patent #'s: 5,451,942; 5,956,674; 5,974,380; 5,978,762; 6,487,535 & other U.S. and worldwide patents issued & pending. DTS and the Symbol are registered trademarks, & DTS 2.0+ Digital Out and the DTS logos are trademarks of DTS, Inc. Product includes software. © DTS, Inc. All Rights Reserved.



HDMI, the HDMI logo and High-Definition Multimedia Interface are trademarks or registered trademarks of HDMI licensing LLC.



DLNA®, the DLNA Logo and DLNA CERTIFIED® are trademarks, service marks, or certification marks of the Digital Living Network Alliance.



The Wi-Fi CERTIFIED Logo is a certification mark of the Wi-Fi Alliance.



ABOUT DIVX VIDEO: DivX® is a digital video format created by DivX, Inc. This is an official DivX Certified device that plays DivX video.

Visit www.divx.com for more information and software tools to convert your files into DivX video.

ABOUT DIVX VIDEO-ON-DEMAND: This DivX Certified® device must be registered in order to play DivX Video-on-Demand (VOD) content. To generate the registration code, locate the DivX VOD section in the device setup menu. Go to vod.divx.com with this code to complete the registration process and learn more about DivX VOD.

"DivX Certified to play DivX video up to HD 1080p."

"Pat. 7,295,673"



YouTube™ is a trademark of Google Inc.



Picasa™ Web Albums is a trademark of Google Inc.

Specification

❖ File information

Format	File extension	Codec
Video	dat, mpg, mpeg, avi, vob, ts, mov, xvid, mp4, mkv, m2t, m2ts, wmv, asf, iso, divx, m1v, m2v, m4v, dvr-ms (Unprotected), flv, m1s, m2p, ifo, tp, trp, m4t, mts	MPEG 1 / 2 / 4, DivX 3 / 4 / 5 / 6, VC1 (WMV9), H.264, MJpeg (SD), AVC
Audio	mp3, wma, wav, ogg, aac, m4a, flac, mka, ape, aif, aiff, mp1, mp2, ac3, mpa, mp4a	MP3, WAV / PCM / LPCM / ADPCM / BLDPCM, AAC, FLAC, DTS, WMA, OGG, Dolby Digital (AC3), AIF / AIFF, APE, WMA Pro, MPEG-1 Layer 1 / 2 / 3, MPEG-2 Layer 1 / 2 / 3
Photo	GIF, BMP, JPEG, TIF / TIFF, PNG	
Subtitle	SRT, SUB, SMI, SSA, ASS, VOBSUB (IDX + SUB), PGS	
Language	English, Korean, Arabic, Chinese, Simplified-Chinese, Dutch, French, German, Greek, Hungarian, Italian, Japanese, Polish, Portuguese, Russian, Spanish, Turkish	
DRM	CGMS-A, HDCP	

- Dolby Digital (AC3) / DTS : 2 ch (Down-mix), 5.1 ch (Pass-through)
- OGG : Audio file only, Sample rate 32 K (Q0) to 192 K (Q2)
- LPCM : Video file only
- FLV : H.264 codec only
- This product may not support file formats other than the formats specified above
- Premium contents DRM is not supported. (iTunes store, Movielink, etc.)

❖ Network specification

Ethernet	10 / 100 Mbps
Wi-Fi	802.11 b / g / n (Russia : 802.11 b / g)
Antenna	Built-in (DP1W Model only)
DLNA	ver.1.5 DMP (Digital Multimedia Players)
Internet Service	AccuWeather, etc.



DP1B Model : Wi-Fi dongle is required for Wireless network connection.
Depending on the region, some of the Wi-Fi service can be limited.
(Ex. Russia region)

❖ LG Service Site

Asia (Country / Region)

Azerbaijan	http://www.lgservice.com
Bangladesh	http://www.lgservice.com
Brunei	http://www.lgservice.com
Cambodia	http://www.lgservice.com
China	http://china.lgservice.com
Hong Kong	http://hk.lgservice.com
India	http://in.lgservice.com
Indonesia	http://id.lgservice.com
Japan	http://jp.lgservice.com
Kazakhstan	http://kz.lgservice.com
Korea	http://www.lgservice.co.kr
Kyrgyzstan	http://www.lgservice.com
Macau	http://mo.lgservice.com
Malaysia	http://my.lgservice.com
Myanmar	http://www.lgservice.com
Nepal	http://www.lgservice.com
Philippines	http://ph.lgservice.com
Singapore	http://sg.lgservice.com
Sri Lanka	http://www.lgservice.com
Taiwan	http://www.lgservice.com
Tajikistan	http://www.lgservice.com
Thailand	http://th.lgservice.com
Turkmen	http://www.lgservice.com
Uzbekistan	http://www.lgservice.com
Vietnam	http://vn.lgservice.com

Africa (Country / Region)

Algeria	http://dz.lgservice.com
Angola	http://ao.lgservice.com
Benin	http://bj.lgservice.com
Botswana	http://www.lgservice.com
Burkina Faso	http://bf.lgservice.com
Cameroon	http://cm.lgservice.com
Canary Islands	http://cn.lgservice.com
Egypt	http://eg.lgservice.com
Ethiopia	http://et.lgservice.com
Gabon	http://ga.lgservice.com
Gambia	http://gm.lgservice.com
Ghana	http://gh.lgservice.com
Guinea	http://gn.lgservice.com
Ivory Coast	http://ic.lgservice.com
Kenya	http://ke.lgservice.com

Lesotho	http://www.lgservice.com
Liberia	http://lr.lgservice.com
Libya	http://www.lgservice.com
Madagascar	http://mg.lgservice.com
Mali	http://ml.lgservice.com
Mauritius	http://mu.lgservice.com
Morocco	http://ma.lgservice.com
Namibia	http://www.lgservice.com
Nigeria	http://ng.lgservice.com
Reunion	http://re.lgservice.com
Senegal	http://sn.lgservice.com
South Africa	http://za.lgservice.com
Sudan	http://www.lgservice.com
Swaziland	http://www.lgservice.com
Togo	http://tg.lgservice.com
Tunisia	http://tn.lgservice.com
Zimbabwe	http://zw.lgservice.com

Middle East (Country / Region)

Afghanistan	http://www.lgservice.com
Bahrain	http://bh.lgservice.com
Cyprus	http://cy.lgservice.com
Iran	http://ir.lgservice.com
Iraq	http://iq.lgservice.com
Israel	http://www.lgservice.com
Jordan	http://jo.lgservice.com
Kuwait	http://kw.lgservice.com
Lebanon	http://lb.lgservice.com
Oman	http://om.lgservice.com
Pakistan	http://pk.lgservice.com
Qatar	http://qa.lgservice.com
Saudi Arabia	http://sa.lgservice.com
Syria	http://sy.lgservice.com
Turkey	http://tr.lgservice.com
U.A.E.	http://ae.lgservice.com
Yemen	http://ye.lgservice.com

Central & South America (Country / Region)

Argentina	http://ar.lgservice.com
Bolivia	http://www.lgservice.com
Brazil	http://br.lgservice.com

❖ LG Service Site

Caribbean	http://www.lgservice.com
Chile	http://cl.lgservice.com
Colombia	http://co.lgservice.com
Costa Rica	http://cr.lgservice.com
Cuba	http://www.lgservice.com
Dominican Republic	http://dm.lgservice.com
Ecuador	http://ec.lgservice.com
El Salvador	http://www.lgservice.com
Guatemala	http://www.lgservice.com
Honduras	http://www.lgservice.com
Nicaragua	http://www.lgservice.com
Panama	http://pa.lgservice.com
Paraguay	http://www.lgservice.com
Peru	http://pe.lgservice.com
Uruguay	http://www.lgservice.com
Venezuela	http://ve.lgservice.com

North America (Country / Region)

Canada	http://ca.lgservice.com
Mexico	http://mx.lgservice.com
Puerto Rico	http://www.lgservice.com
U.S.A.	http://www.lgusa.com

Europe (Country / Region)

Albania	http://www.lgservice.com
Austria	http://www.lgservice.com
Belgium	http://be.lgservice.com
Bosnia-Herzegovina	http://www.lgservice.com
Bulgaria	http://bg.lgservice.com
Byelorussia	http://www.lgservice.com
Croatia	http://www.lgservice.com
Czech Republic	http://cz.lgservice.com
Denmark	http://dk.lgservice.com
Estonia	http://ee.lgservice.com
Finland	http://fi.lgservice.com
France	http://fr.lgservice.com
Germany	http://de.lgservice.com
Greece	http://gr.lgservice.com
Hungary	http://hu.lgservice.com
Iceland	http://is.lgservice.com
Ireland	http://ie.lgservice.com
Italy	http://italy.lgservice.com
Kazakhstan	http://kz.lgservice.com

Latvia	http://lv.lgservice.com
Lithuania	http://lt.lgservice.com
Luxembourg	http://lu.lgservice.com
Macedonia	http://www.lgservice.com
Moldova	http://www.lgservice.com
Netherlands	http://nl.lgservice.com
Norway	http://no.lgservice.com
Poland	http://pl.lgservice.com
Portugal	http://pt.lgservice.com
Romania	http://ro.lgservice.com
Russia	http://ru.lgservice.com
Serbia	http://www.lgservice.com
Slovakia	http://www.lgservice.com
Slovenia	http://www.lgservice.com
Spain	http://es.lgservice.com
Sweden	http://se.lgservice.com
Switzerland	http://www.lgservice.com
Ukraine	http://ua.lgservice.com
United Kingdom	http://gb.lgservice.com

Oceania (Country / Region)

Australia	http://au.lgservice.com
-----------	---

LG Electronics Inc.

Home page : www.lge.com.au
 Service site : <http://au.lgservice.com>
 Customer information centre
 1800-LG-HELP (54-4357)

Fiji	http://www.lgservice.com
New Caledonia	http://www.lgservice.com
New Zealand	http://nz.lgservice.com
Papua New Guinea	http://www.lgservice.com